



International Patent Public No.:
WO 2006/007772
China Patent No.: ZL02220153.X,
ZL200420078956.5
US Patent No.: 7549446
India Patent No.: 232582
Russia Patent No.:2349819
South Korea Patent No.:10-0914137
Mexico Patent No.: 268581
Australia Patent No.: 2005263257
Philippine Patent No.: 1-2006-502553
Taiwan Patent No.:M287896

Multi-functional Flow Control Valve for Water Treatment Systems

60002 (Old Model No.: F65C)

70002 (Old Model No.: F69C)

User manual



Please read this manual in details
before using this valve and keep it properly
in order to consult in the future

0WRX.466.522

MODEL 60002-F65C/70002-F69C

MODEL 60002-F65C/70002-F69C

Before the valve put into use, please fill in the below content so as to help us to refer in the future.

Softener System Configuration

Tank Size: Dia. _____mm, Height _____mm;

Resin Volume _____L; Brine Tank Capacity _____L;

Hardness of Raw water _____mmol/L;

Pressure of Inlet Water _____MPa;

Control Valve Model _____ ; Number _____ ;

The Specification of Drain Line Flow Control _____;

Injector No. _____.

Water Source: Ground-water Filtered Ground-water Tap Water Other _____.

● The default configuration of the Brine Line Flow Control is 3#, the injector is 5#, unless otherwise specified.

Catalogue

Notice.....	3
1. Product Overview.....	4
1.1. Main Application & Applicability.....	4
1.2. Product Characteristics.....	4
1.3. Service Condition.....	4
1.4. Product Structure and Technical Parameters.....	5
1.5. Installation.....	6
2. Basic Setting & Usage.....	9
2.1. The Function of PC Board.....	9
2.2. Basic Setting & Usage.....	9
3. Application.....	10
3.1. Softener Flow Chart.....	10
3.2. System Configuration and Flow Rate Characteristic.....	12
3.3. Trial Running.....	14
3.4. Trouble-Shooting.....	15
3.5. Spare Part and Part No.....	17
4. Warranty Card.....	21

Notice

- To ensure normal operation of the valve, please consult with professional installation or repairing personnel before use it.
- If there are any of pipeline engineering and electric works, there must be finished by professional at the time of installation.
- Do not use the control valve with the water that is unsafe or unknown quality.
- Depending on the changing of working environment and water requirement, each parameter of softener should be adjusted accordingly.
- When the water treatment capacity is too low, please check the resin. If the reason is shortage of resin, please add; if the resin is turn to reddish brown or broken, please replace.
- Test water periodically to verify that system is performing satisfactorily.
- Sodium used in the water softening process should be considered as part your overall dietary salt intake. Contact doctor if you are on a low sodium diet.
- Ensure that there is solid salt all the time in the brine tank in the course of using, when this valve is used for softening. The brine tank should be added the clean water softening salts only, at least 99.5% pure, forbidding use the small salt.
- Do not put the valve near the hot resource, high humidity, corrosive, intense magnetic field or intense vibrations environment. And do not leave it outside.
- Forbidden to carry the injector body. Avoid to use injector body as support to carry the system.
- Forbidden to use the brine tube or other connectors as support to carry the system.
- Please use this product under the water temperature between 5~50℃, water pressure 0.15~0.6MPa. Failure to use this product under such conditions voids the warranty.
- If the water pressure exceeds 0.6Mpa, a pressure reducing valve must be installed before the water inlet. While, if the water pressure under 0.15MPa, a booster pump must be installed before the water inlet.
- It is suggested to install PPR pipe, corrugated pipe or UPVC pipe, instead of TTLSG pipe.
- Do not let children touch or play, because carelessness operating may cause the procedure changed.
- When the attached cables of this product and transformer are changed, they must be changed to the one that is from our factory.

1. Product Overview

1.1. Main Application & Applicability

Used for softening or demineralization water treatment systems.

Be suitable for

Residential softening system

Ion exchange equipment

Boiler softening water system

RO pretreatment softening system, etc.

1.2. Product Characteristics

Simple structure and reliable sealing

It adopts hermetic head faces with high degree pottery and corrosion resistance for opening and closing. It combines with Service, Backwash, Brine & Slow Rinse, Brine Refill and Fast Rinse.

No water pass the valve in regeneration in single tank type

Manual function

Realize regeneration immediately by pushing manual button  at any time

One-button start

Control the regeneration time, only need press the one-button start button then start regeneration.

Status indicator

Every position has corresponding status indicator.

More simple and more economical

Customize time parameter value, easy to operate and more economical.

1.3 Service Condition

Runxin Valve should be used under the below conditions.

Items		Requirement
Working conditions	Water pressure	0.15MPa~0.6MPa
	Water temperature	5℃~50℃
Working environment	Environment temperature	5℃~50℃
	Relative humidity	≤95% (25℃)
	Electrical facility	AC100~240V/50~60Hz

MODEL 60002-F65C/70002-F69C

Inlet water quality	Water turbidity	Down-flow regeneration < 5FTU; Up-flow regeneration < 2FTU
	Water hardness	First Grade Na ⁺ < 6.5mmol/L; Second Grade Na ⁺ < 10mmol/L
	Free chlorine	< 0.1mg/L
	Iron ²⁺	< 0.3mg/L
	CODMn	< 2mg/L (O ₂)

In the above table, First Grade Na⁺ represents First Grade Na⁺ Exchanger. Second Grade Na⁺ represents Second Grade Na⁺ Exchanger.

When the water turbidity exceeds the conditions, a filter should be installed on the inlet of control valve.

When the water hardness exceeds the conditions, the outlet water hardness will hardly reach the requirement of boiler feed water (0.03 mmol/L). It is suggested to adopt second grade softener.

1.4. Product Structure and Technical Parameters

Product dimension

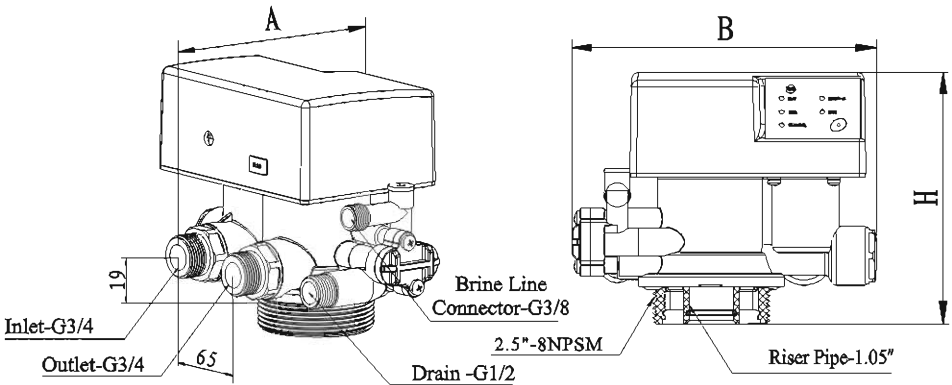

Model	A (mm) max	B (mm) max	H (mm) max	Flow Rate m ³ /h @0.3MPa	Regeneration Mode
F65C/60002	127.5	187.8	154.7	2.0	Down-flow
F69C/70002	127.5	187.8	154.7	2.0	Up-flow

Attention:

1. The appearance is just for reference. It is subjected to the real product.
2. OD-Outer Diameters, 1.05OD=26.7mm
3. Transformer Output: DC12V/1.5A

MODEL 60002-F65C/70002-F69C

1.5. Installation

A. Installation notice

Before installation, read all those instructions completely. Then obtain all materials and tools needed for installation

The installation of product, pipes and circuits, should be accomplished by professional to ensure the product can operate normally.

Perform installation according to the relative pipeline regulations and the specification of Water Inlet, Water Outlet, Drain Outlet, Brine Line Connector

B. Device location

- ① The filter or softener should be located close to drain.
- ② Ensure the unit is installed in enough space for operating and maintenance
- ③ Brine tank need to be close to softener.
- ④ The unit should be kept away the heater, and not be exposed outdoor. Sunshine or rain will cause the system damage
- ⑤ Please avoid to install the system in one Acid/Alkaline, Magnetic or strong vibration circumstance, because above factors will cause the system disorder.
- ⑥ Do not install the filter or softener, drain pipeline in circumstance which temperature may drop below 5°C, or above 50°C.
- ⑦ One place is recommended to install the system which cause the minimum loss in case of water leaking.

C. Pipeline installation

① Install control valve

a. As the Figure 1-1 shows, select the riser pipe with 26.7mm OD, glue the riser pipe to the bottom strainer and put it into the mineral tank, cut off the exceeding tube out of tank top

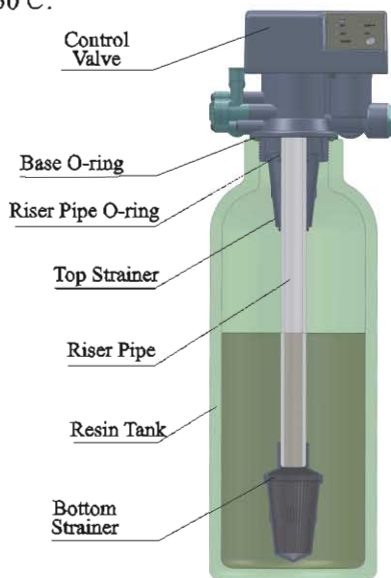

Figure 1-1

MODEL 60002-F65C/70002-F69C

opening. Plug the riser tube in case of mineral entering.

b. Fill the mineral to the tank, and the height is accordance with the design code.

c. Remove the tap covering on the central tube and check if the riser tube is on the central of tank.

d. Install the top distributor to the valve and insert the riser tube into control valve and screw tight control valve

Note:

● The length of riser pipe should be neither higher 2mm nor lower 5mm than tank top opening height, and its top end should be rounded to avoid damage of O-ring inside the valve

● Avoid floccules substance together with resin to fill in the mineral tank.

● Avoid O-ring inside control valve falling out while rotating it on the tank

② Pipeline connection

a. As Figure1-2 shows, install a pressure gauge in water inlet.

b. Install valve A, valve B, valve C and valve D in inlet pipe, outlet pipe, the middle of the inlet and outlet pipe. valve D is sampling valve (Or adopt F70B by-pass valve)

c. Install a check valve in water outlet

d. Inlet pipe should be in parallel with outlet pipe. Support inlet and outlet pipeline with fixed holder.

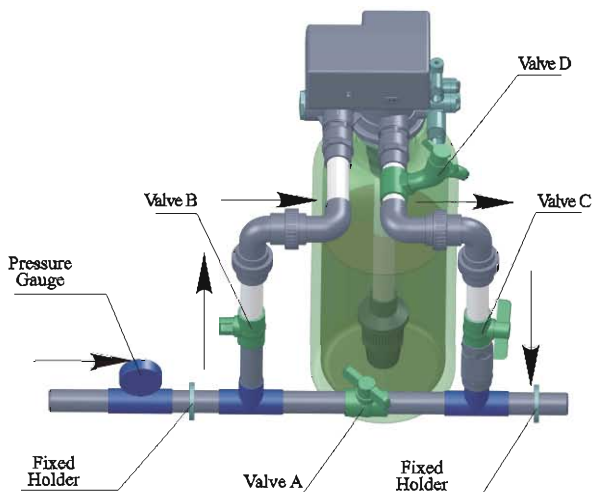

Figure1-2

MODEL 60002-F65C/70002-F69C

Note:

● If the water outlet pipe or water storage tank installed higher than control valve or parallel interlock system with multi-outlets, a liquid level controller must be installed in brine tank. Or else, the water in outlet pipe or water tank will flow backwards into brine tank when backwash.

● If making a soldered copper installation, do all sweat soldering before connecting pipes to the valve. Torch heat will damage plastic parts.

● When turning threaded pipe fittings onto plastic fitting, use care not to cross thread or broken valve.

③ Install drain pipe

a. As Figure 1-3 shows: slide the drain hose connector into drain outlet.

b. Insert drain line flow control into drain outlet

c. Screw drain hose connector into drain outlet, and lock it.

d. Locate the drain hose.

Note:

● Control valve should be higher than drain outlet, and be better not far from the drain hose.

● Be sure not connect drain with sewer, and leave a certain space between them, avoid wastewater be absorbing to the water treatment equipment, such as showed in the Figure 1-3.

④ Connect brine tube

a. As Figure 1-4 shows, slide 3/8" brine tube hose connector over end of brine tube.

b. Insert tube bushing into the end of brine tube.

c. Insert the red brine line flow control into valve brine line connector (Attention: cone side of control should face into valve)

d. Tighten brine draw hose connector onto brine line connector.

e. Connect the other end of brine tube with the brine tank. (The liquid level controller and air-blocker should be installed in the brine tank.)

Note: The brine tube and drain pipeline should not be bended or plugged.

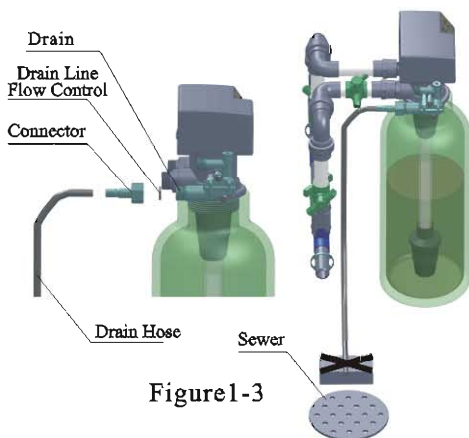

Figure 1-3

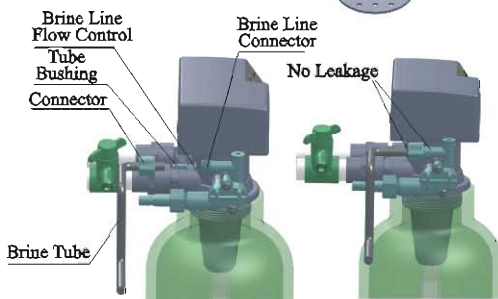
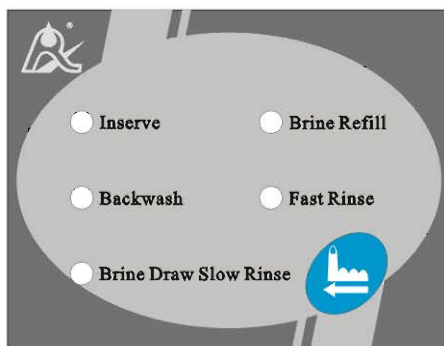



Figure 1-4

2. Basic Setting & Usage

2.1. The Function of PC Board



- When the system is in Service status, only press  button, then the system will start to regenerate, otherwise, the system will not regenerate.
- After start-up the regeneration, the system will process the complete regeneration circle automatically, under the setting parameter (As the blow table shows), then back to service status.
- During the regeneration circle, if you would like to finish the current status in advance, press  button to process to next status.

2.2 Basic setting

Controller setting (Default configuration)

Backwash	Brine & Slow Rinse	Brine Refill	Fast Rinse
1 min.	35 min.	2min.	2 min.

Notes: The time parameter can be queried and adjusted through the USB adjuster. (USB adjuster is five digit display board, please buy separately if necessary)

3. Application

3.1 Softener Flow Chart

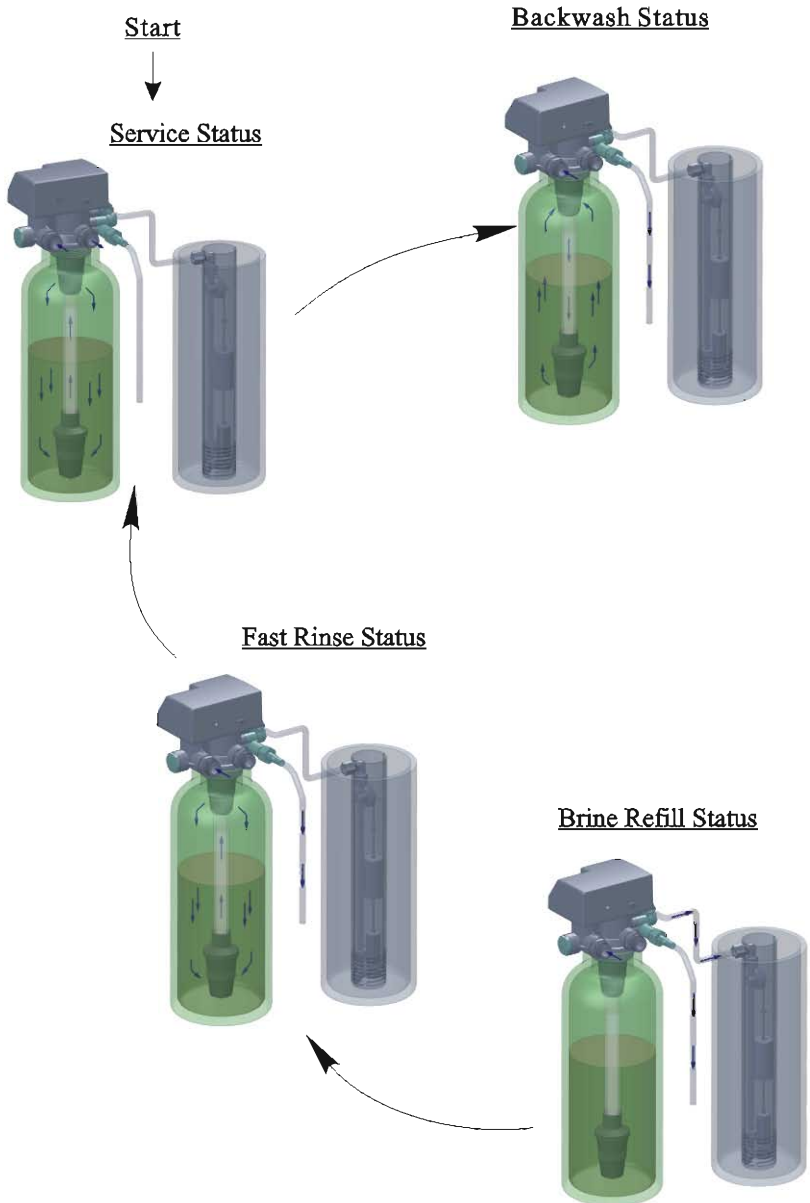

MODEL 60002-F65C/70002-F69C

Up-flow Regeneration

Brine Draw Status

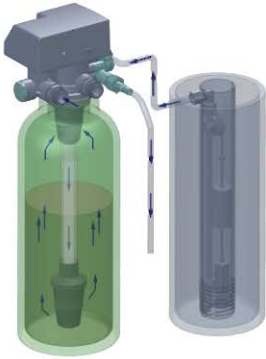

Slow Rinse Status

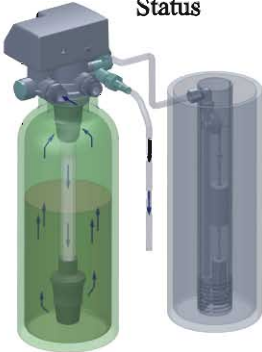

Down-flow Regeneration

Brine Draw Status

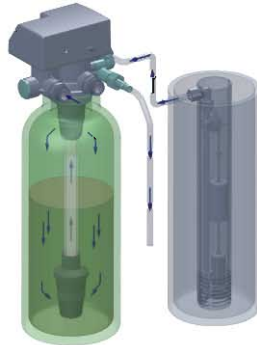

Slow Rinse Status

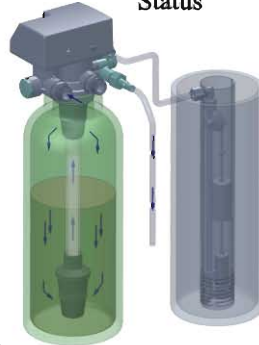

MODEL 60002-F65C/70002-F69C

3.2 System Configuration and Flow Rate characteristic

A. Product Configuration

Product configuration with tank, resin volume, brine tank and injector

Tank Size(mm)	Resin Volume(L)	Flow Rate (t/h)	Brine Tank Size (mm)	The Minimum Salt Consumption for Regeneration (Kg)	Injector Model
φ 180 × 1130	16	0.5	φ 200 × 500	2.40	6302
φ 205 × 1300	25	0.7	φ 390 × 810	4.00	6303
φ 255 × 1390	40	1.2	φ 390 × 810	6.00	6305
φ 300 × 1650	60	1.8	φ 450 × 940	9.00	6306

Note: The flow rate calculation is based on linear velocity 25m/hr; the minimum salt consumption for regeneration calculation is based on salt consumption 150g / L (Resin).

B. Flow Rate characteristic

1). Pressure-flow rate curve

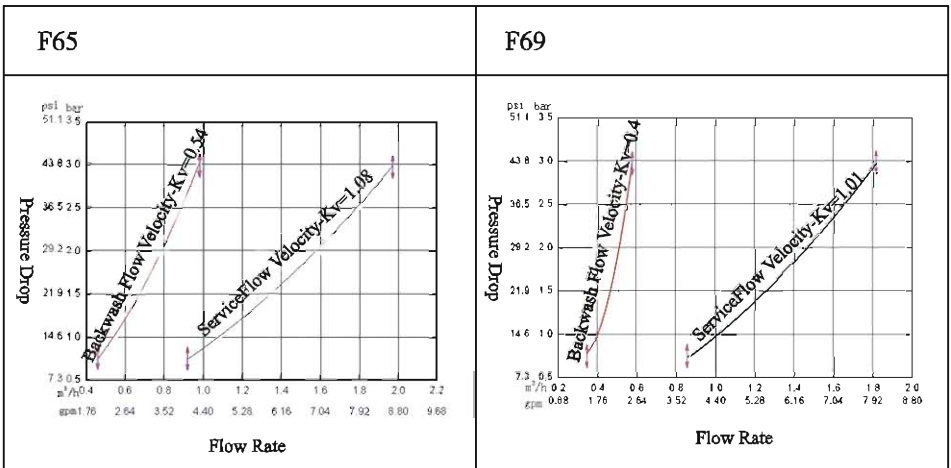

MODEL 60002-F65C/70002-F69C

2). Injector parameter table

Inlet Pressure	Draw Rate (L/M)									
	6301 Coffee	6302 Pink	6303 Yellow	6304 Blue	6305 White	6306 Black	6307 Purple	6308 Red	6309 Green	6310 Orange
0.15	0.81	1.12	1.58	2.21	2.45	3.30	3.44	4.08	5.19	5.69
0.20	0.95	1.41	1.87	2.53	2.89	3.88	4.21	4.83	5.36	6.80
0.25	0.99	1.61	2.08	2.79	3.30	4.30	4.66	5.39	6.86	7.65
0.30	1.30	1.81	2.18	3.05	3.66	4.74	5.15	5.95	7.50	8.60
0.35	1.45	1.96	2.39	3.27	3.94	5.02	5.55	6.51	8.30	9.57
0.40	1.56	2.12	2.55	3.50	4.25	5.41	5.88	6.77	8.74	9.90

3). Configuration for Standard Injector and Drain Line Flow Control

Tank Dia Mm	Injector Model	Injector Color	Draw Rate	Slow Rinse	Brine Refill	DLFC	Backwash/ Fast Rinse
			L/m	L/m	L/m		L/m
150	6301	Coffee	1.30	0.91	3.0	1#	4.7
175	6302	Pink	1.81	1.32	3.7	1#	4.7
200	6303	Yellow	2.18	1.73	3.8	2#	8.0
225	6304	Blue	3.05	2.14	3.3	2#	8.0
250	6305	White	3.66	2.81	4.3	3#	14.4
300	6306	Black	4.74	3.32	4.2	3#	14.4

Note: Above data for the product configuration and relevant characteristics are only for reference. When put in practice, please subject to the different requirements of raw water hardness and application.

MODEL 60002-F65C/70002-F69C

3.3 Trial Running

Fix the valve on the tank, connect all the pipelines, set all the parameters then do as follows:

A. Turn off the inlet and outlet of the valve B and valve C, turn on the by-pass valve A, and wash clean the internal pipeline then turn off the valve A, as shown in figure (1-3)

B. Pour the specified water into the brine tank, and adjust the check valve, then put the solid salt into the brine tank, let it dissolves in water as far as possible.

C. Connect the power supply. Press the button  turn to back wash status, open valve B to 1/4 slowly to let water into brine tank. Now can hear the sound of air through the outlet pipe, then fully open the valve B after air exhausted, wash clean the resin tank until drain the clean water from outlet. About take 8~10min.

D. Press button  complete regeneration. Choose position brine and slow rinse turn to brine and slow rinse status. The check valve will closed and turn to slow rinse status, after all the water absorbed. The brine and slow rinse cost 60~ 65min.

E. Press button  stop brine and slow rinse. Choose position brine tank refill and start refill, until the water levels reach the enactment water level of high, then put the solid salt into the brine tank, take 5~6min.

F. Press button  stop refill. Choose fast rise position start fast rinse. After 10~15min., take out some outlet water for testing: if the water hardness reach the requirement, and the chloridion in the water is almost the same compared with the inlet water, then go to the next step.

G. Press , stop fast rinse, then making the control valve return to Service and start to running.

● When the control valve enter into the regeneration , all program can be finished automatically according to the setting time; if you want one of steps terminated early, you can press  .

● If water inflow too fast, the media in tank will be damaged. When water inflow slowly, there is a sound of air emptying from drain pipeline.

● After changing resin, please empty air in the resin according to the above Step C.

● In the process of trial running, please check the water situation in all position, ensuring there are no resin leakage

● The time for Backwash, Brine& Slow Rinse, Brine Refill and Fast Rinse position can be set and executed according to the calculation in the formula or suggestions from the control valve suppliers.

MODEL 60002-F65C/70002-F69C

3.4. Trouble-Shooting

A. Control valve Fault

Problem	Cause	Solution
1. Softener fails to regenerate.	A. Electrical service to unit has been interrupted. B. Controller is defective C. Motor fails to work.	A. Assure permanent electrical service(check fuse, plug, pull chain or switch). B. Replace controller C. Replace motor
2. Softener supply hard water.	A. Bypass valve is open or leaking. B. No salt in brine tank. C. Injector plugged. D. Insufficient water flowing into brine tank. E. Leak at O-ring on riser pipe. F. Internal valve leak. G. Regeneration cycles not correct. H. Shortage of resin.	A. Close or repair bypass valve. B. Add salt to brine tank and maintain salt level above water level. C. Change or clean injector. D. Check brine tank refill time. E. Make sure riser pipe is not cracked. Check o-ring and tube pilot. F. Change valve body. G. Set correct regeneration cycles in the program. H. Add resin to mineral tank and check whether resin leaks.
3. Softener fails to draw brine.	A. Line pressure is too low. B. Brine line is plugged. C. Brine line is leaking. D. Injector is plugged. E. Internal control leak. F. Drain line is plugged. G. Sizes of injector and DLFC not match with tank	A. Increase line pressure. B. Clean brine line. C. Replace brine line. D. Clean or replace new parts. E. Replace valve body. F. Clean drain line flow control. G. Select correct injector size and DLFC according to the P13 Requirements.
4. Unit used too much salt	A. Improper salt setting. B. Excessive water in brine tank.	A. Check salt usage and salt setting. B. See problem no.6.
5. Excessive water in brine tank.	A. Overlong refilling time. B. Foreign material in brine line. C. Foreign material in brine valve and plug drain line flow control. D. Not install safety brine valve but power failure whiling salting. E. Safety brine valve breakdown.	A. Reset correct refilling time. B. Clean brine line. C. Clean brine valve and brine line. D. Stop water supplying and restart pr install safety brine valve in salt tank. E. Repair or replace safety brine valve.
6. The salt water flow into outlet pipeline	A. Brine valve is not closed completely B. Time of fast rinse setting too short	A. Repair brine valve or clean it.. B. Increase the fast rinse time.

MODEL 60002-F65C/70002-F69C

Control Valve Fault (cont.)

<p>7. Pressure lost or iron in conditioned water.</p>	<p>A. Iron in the water supply pipe. B. Iron mass in the softener. C. Fouled resin bed. D. Too much iron in the raw water.</p>	<p>A. Clean the water supply pipe. B. Clean valve and add resin cleaning chemical, increase frequency of regeneration. C. Check backwash, brine draw and brine tank refill. Increase frequency of regeneration and backwash time. D. Iron removal equipment is required to install before softening.</p>
<p>8. Loss of mineral through drain line.</p>	<p>A. Air in water system. B. Bottom strainer broken. C. Improperly sized drain line control.</p>	<p>A. Assure that well system has proper air eliminator control. B. Replace new bottom strainer. C. Check for proper drain rate.</p>
<p>9. Control cycle continuously.</p>	<p>A. Locating signal wiring breakdown. B. Controller is faulty. C. Foreign material stuck the driving gear.</p>	<p>A. Check and connect locating signal wiring. B. Replace controller. C. Take out foreign material.</p>
<p>10. Drain flows continuously.</p>	<p>A. Internal valve leak. B. When electricity fails to supply, valve stops backwash or rapid rinse position.</p>	<p>A. Check and repair valve body or replace it. B. Adjust valve to service position or turn off bypass valve and restart when electricity supply.</p>
<p>11. Interrupted or irregular brine.</p>	<p>A. Water pressure too low or not stable. B. Injector is plugged or faulty. C. Air in resin tank. D. Floccules in resin tank during backwash.</p>	<p>A. Increase water pressure. B. Clean or replace injector. C. Check and find the reason. D. Clean the floccules in resin tank.</p>
<p>12. Water flow out from drain or brine pipe after regeneration.</p>	<p>A. Foreign material in valve which makes valve can't be closed completely. B. Hard water mixed in valve body. C. Water pressure is too high which result in valve doesn't get the right position. D. Under the Backwash position, the outlet line and brine line are connected.</p>	<p>A. Clean foreign material in valve body. B. Change valve core or sealing ring. C. Reduce water pressure or use pressure release function. D. install a check valve, solenoid valve in front of the outlet or install a liquid level controller in the brine tank.</p>
<p>13. Decrease of cycle water production</p>	<p>A. Regeneration not setting properly B. Fouled resin bed. C. Salt setting not proper D. Raw water quality deterioration.</p>	<p>A. Regenerate according to the correct operation requirement. B. Increase backwash flow rate and time, clean or change resin C. Set proper salt. D. Regenerate unit by manual temporary, then reset regeneration cycle.</p>

MODEL 60002-F65C/70002-F69C

B. Controller Fault

Problem	Cause	Solution
1. The indicating light unlit.	A. The connecting cables damaged. B. Display board damaged. C. Control board damaged. D. Electricity is interrupted.	A. Replace the connecting cables. B. Replace Display board. C. Replace control board. D. Check electricity.

3.5.Assembly & Parts

F65C&F69C Valve Body Components .

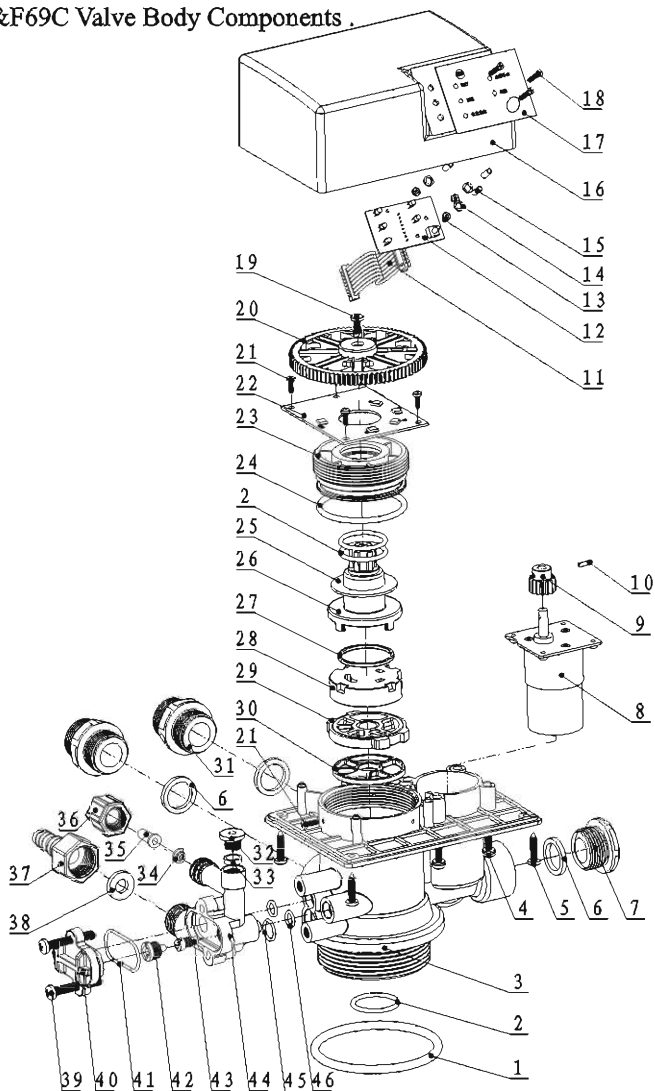

MODEL 60002-F65C/70002-F69C

F65C Valve Body Components

Item No.	Description	Part No.	Quantity	Item No.	Description	Part No.	Quantity
1	O-ring 73 × 5.3	8378143	1	24	O-ring 50.39 × 3.53	8378107	1
2	O-ring 25.8 × 2.65	8378078	3				
3	Valve Body (ABS+CF10)	5022018	1	25	Anti-friction Washer	8216010	1
	Valve Body (PPO+CF20)	5022019		26	Shaft	8258009	1
4	Screw, Cross M4 × 25	8902008	4	27	Moving Seal Ring	8370053	1
5	Screw, Cross ST3.9 × 19	8909016	4	28	Moving Disk	8459013	1
6	Seal Ring φ 24X φ 18 × 3	8371019	3	29	Fixed Disk	8469012	1
7	Plug	8323005	1	30	Seal Ring	8370025	1
8	Motor	6158006	1	31	Seal Ring	8458011	1
9	Small Gear, Motor	8241010	1	32	Plug	8323002	1
10	Pin	8993003	1	33	Plug	8370003	1
11	Connecting Cables for Display Board	5512003	1	34	Brine Line Flow Control	8468002	1
12	Display Board	6381014	1	35	Tube	8457004	1
13	Hexagonal Nut	8940019	3	36	Hexagonal Nut	8940001	1
14	Spring Washers	8953002	3	37	Joint	8458017	1
15	Tube	8457006	3	38	Drain Line Flow Control	8468007	1
16	Control Box	8300009	1	39	Screw, Cross M5 × 35	8902017	2
17	Stick	8865009	1	40	Cover, Injector	8315001	1
18	Screw, Cross M2.5 × 16	8005005	1	41	O-ring 30 × 1.8	8378025	1
19	Screw, Cross ST3.9 × 13	8909013	1	42	Nozzle, Injector	8454009	1
20	Big Gear, Driven	5241005	1	43	Throat, Injector	8467009	1
21	Screw, Cross ST2.9 × 9.5	8909008	7	44	Injector Body	8008001	1
22	Locating Board	8382037	1	45	O-ring 10.82 × 1.78	8378012	1
23	Fitting Nut	8092007	1	46	O-ring 7.5 × 1.8	8378016	2

MODEL 60002-F65C/70002-F69C

F69C Valve Body Components

Item No.	Description	Part No.	Quantity	Item No.	Description	Part No.	Quantity
1	O-ring 73 × 5.3	8378143	1	24	O-ring 50.39 × 3.53	8378107	1
2	O-ring 25.8 × 2.65	8378078	3				
3	Valve Body (ABS+CF10)	5022018	1	25	Anti-friction Washer	8216010	1
	Valve Body (PPO+CF20)	5022019		26	Shaft	8258009	1
4	Screw, Cross M4 × 25	8902008	4	27	Moving Seal Ring	8370053	1
5	Screw, Cross ST3.9 × 19	8909016	4	28	Moving Disk	8459013	1
6	Seal Ring φ 24X φ 18 × 3	8371019	3	29	Fixed Disk	8469012	1
7	Plug	8323005	1	30	Seal Ring	8370025	1
8	Motor	6158006	1	31	Seal Ring	8458011	1
9	Small Gear, Motor	8241010	1	32	Plug	8323002	1
10	Pin	8993003	1	33	Plug	8370003	1
11	Connecting Cables for Display Board	5512003	1	34	Brine Line Flow Control	8468002	1
12	Display board	6381014	1	35	Tube	8457004	1
13	Hexagonal Nut	8940019	3	36	Hexagonal Nut	8940001	1
14	Spring washers	8953002	3	37	Joint	8458017	1
15	Tube	8457006	3	38	Drain Line Flow Control	8468007	1
16	Control Box	8300009	1	39	Screw, Cross M5 × 35	8902017	2
17	Stick	8865009	1	40	Cover, Injector	8315001	1
18	Screw, Cross M2.5 × 16	8005005	1	41	O-ring 30 × 1.8	8378025	1
19	Screw, Cross ST3.9 × 13	8909013	1	42	Nozzle, Injector	8454009	1
20	Big Gear, Driven	5241005	1	43	Throat, Injector	8467009	1
21	Screw, Cross ST2.9 × 9.5	8909008	7	44	Injector Body	8008001	1
22	Locating Board	8382038	1	45	O-ring 10.82 × 1.78	8378012	1
23	Fitting Nut	8092007	1	46	O-ring 7.5 × 1.8	8378016	2

MODEL 60002-F65C/70002-F69C

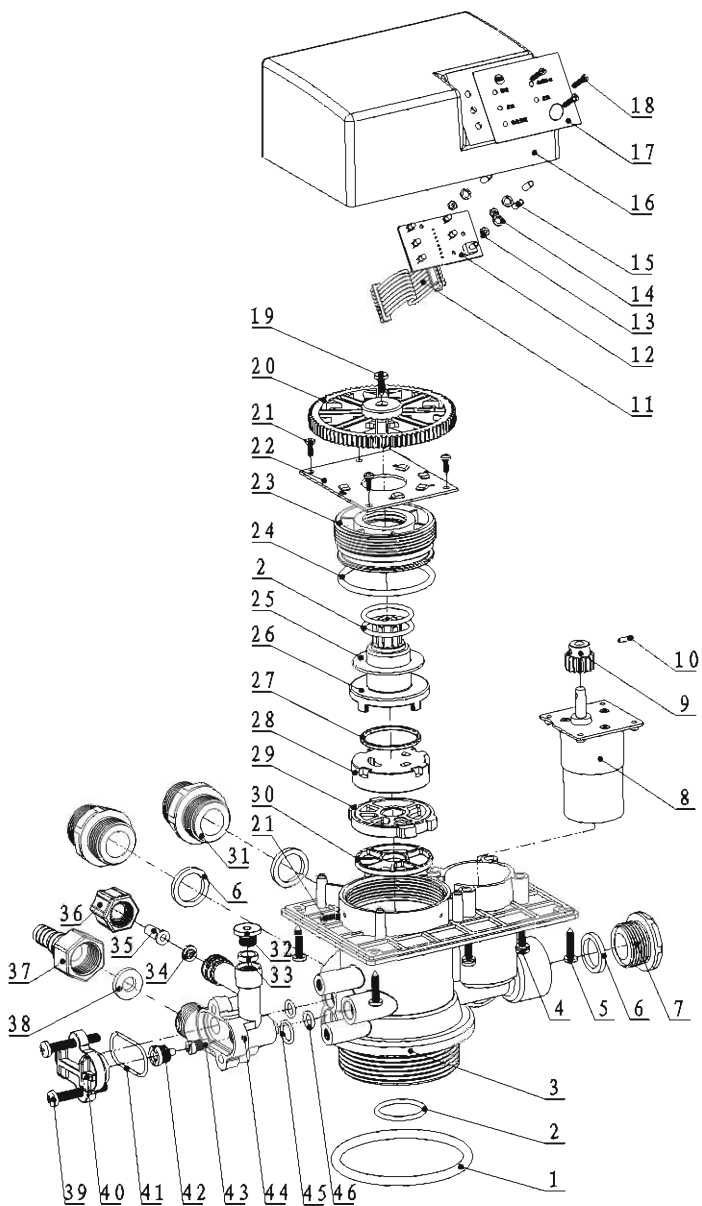

4.Warranty Card

Dear client:

This warranty card is the guarantee proof of RUNXIN brand multi-functional flow control valve. It is kept by client self. You could get the after-sales services from the supplier which is appointed by RUNXIN manufacturer. Please keep it properly. It couldn't be retrieved if lost. It couldn't be repaired free of charge under the below conditions:

1. Guarantee period expired.(One year);
2. Damage resulting from using, maintenance, and keeping that are not in accordance with the instruction;
3. Damage resulting from repairing not by the appointed maintenance personnel;
4. Content in guarantee proof is unconfirmed with the label on the real good or be altered;
5. Damage resulting from force majeure.

Product Name	 润新 RUNXIN	Multi-functional Flow Control Valve for Water Treatment Systems			
Model		Code of Valve Body			
Purchase Company Name		Tel/Cel.			
Problem					
Solution					
Date of Repairing		Date of Accomplishment		Maintenance Man Signature	

When product need warranty service, please fill in the below content and sent this card together with the product to the appointed suppliers or Runxin company.

End-user Company Name		Tel/Cel.			
Purchase Company Name		Tel/Cel.			
Model	Code of Valve Body				
Tank Size ϕ ×		Resin Tank Size	L	Raw Water Hardness	mmol/L
Water Source: Ground-water <input type="checkbox"/> Tap Water <input type="checkbox"/>		Water Treatment Capacity	m ³	Backwash Time	min
Brine & Slow Rinse Time	min	Brine Refill Time	min	Fast Rinse Time	min
Problem Description					



WENZHOU RUNXIN MANUFACTURING MACHINE CO.,LTD

ADD: Jinger Road, Shatou Group, Linjiang, Lucheng District, Wenzhou, Zhejiang, China

Tel: +86-577-88635628 88630038 Fax: +86-0577-88633258

Http://www.run-xin.com Email:sales@run-xin.com