



International Patent Public No.:  
WO 2006/007772  
China Patent No.:  
ZL02220153.X,  
ZL200420078956.5  
US Patent No.: 7549446  
India Patent No.:232582  
Russia Patent No.:2349819  
South Korea Patent No.:10-0914137  
Mexico Patent No.: 268581  
Australia Patent No.: 2005263257  
Philippine Patent No.: 1-2006-502553  
Taiwan Patent No.:M287896

## Control Valve for Floating Bed Water Treatment Systems

93504 (Old Model No.: F83A1)  
93604 (Old Model No.: F83A3)

## Instruction Manual



**Please read this manual in details  
before using this valve and keep it properly  
in order to consult in the future**

0WRX.466.518

## MODEL:93504-F83A1/93604-F83A3

Before the valve put into use, please fill in the below content so as to help us to refer in the future.

### Softener System Configuration

Tank Size: Dia. \_\_\_\_\_ mm, Height \_\_\_\_\_ mm;

Resin Volume \_\_\_\_\_ L; Brine Tank Capacity \_\_\_\_\_ L;

Hardness of Raw Water \_\_\_\_\_ mmol/L;

Pressure of Inlet Water \_\_\_\_\_ MPa;

Control Valve Model \_\_\_\_\_ ; Number \_\_\_\_\_ ;

The Specification of Drain Line Flow Control \_\_\_\_\_ ;

Injector No. \_\_\_\_\_.

Water Source: Ground-water  Filtered Ground-water  Tap Water  Other \_\_\_\_\_.

### Parameter Set

Parameter	Unit	Factory Default	Actual Value
Control Mode A-01 (02, 03, 04)	/	A-01	
Water Treatment Capacity (Meter type)	m <sup>3</sup>	10	
Operation Days (Time clock type, by days)	D.	03	
Operation Hours (Time clock type, by hours)	H.	20	
Regeneration Time	Hr.:Min.	02 : 00	
Settling Bed Time	Hr.:Min.	30	
Brine & Slow Rinse Time	Min.	60	
Brine Refill Time	Min.	05	
Fast Rinse Time	Min.	10	
Interval Regeneration Days	D.	30	
Output Mode b-01 (02)	/	b-01	

● If there is no special requirement when product purchase, we choose 5# drain line flow control and 9# injector for the standard configuration.

## Catalogue

Notice.....	3
1. Product Overview.....	4
1.1. Main Application & Applicability.....	4
1.2. Product Characteristics.....	4
1.3. Service Condition.....	6
1.4. Product Structure and Technical Parameters.....	6
1.5. Installation.....	7
2. Basic Setting & Usage.....	9
2.1. The Function of PC Board.....	9
2.2. Basic Setting & Usage.....	11
3. Application.....	14
3.1. Softener Flow Chart.....	14
3.2. The Function and Connection of PC Board.....	16
A. Signal Output.....	17
B. Interlock.....	18
C. Remote Handling Input.....	19
D. Interlock System.....	19
E. Series System.....	19
3.3. System Configuration and Flow Rate Curve.....	20
3.4. Parameter Settlement.....	21
3.5. Parameter Enquiry and Setting.....	23
3.6. Trial Running.....	26
3.7. Trouble-Shooting.....	27
3.8. Spare Part and Part No.....	30
4. Warranty Card.....	33

## Notice

- To ensure normal operation of the valve, please consult with professional installation or repairing personnel before use it.
- If there are any of pipeline engineering and electric workers, there must be finished by professional at the time of installation.
- Do not use the control valve with the water that is unsafe or unknown quality.
- If the working conditions and water quality are changed requirement, each parameter of softener should be adjusted accordingly.
- When the water treatment capacity is too low, please check the resin. If the cause is shortage of resin, please add it; if the resin turns reddish brown or broken, please replace it.
- Test water periodically to verify that system is performing satisfactorily.
- Sodium used in the water softening process should be considered as part your overall dietary salt intake. Contact doctor if you are on a low sodium diet.
- Ensure that there is solid salt all the time in the brine tank in the course of using, when this valve is used for softening. The brine tank should be added the clean water softening salts only, at least 99.5% pure, forbidding use the fine salt.
- Do not place the valve near heat sources or surroundings with high humidity, corrosive, intense magnetic field or intense vibrations . And do not leave it outdoors.
- Forbidden to carry the injector body. Avoid to use injector body as a handle or supporting point support to carry the system.
- Forbidden to use the brine tube or other connectors as support to carry the system.
- Please use this product under the water temperature between 5 ~ 50 °C, water pressure 0.15 ~ 0.6MPa. Failure to use this product under such conditions voids the warranty.
- If the water pressure exceeds 0.6Mpa, a pressure reducing valve must be installed before the water inlet. While, if the water pressure under 0.15MPa, a booster pump must be installed before the water inlet.
- It is suggested to install PPR pipe, corrugated pipe or UPVC pipe, instead of TTLSG pipe.
- Do not let children touch or play, because carelessness operating may cause the procedure changed.
- When the attached cables of this product and transformer are damaged, they must be changed to the one that is from our factory.

# 1. Product Overview

## 1.1. Main Application & Applicability

Used for softening water treatment systems.

Be suitable for softening system which raw water hardness is less than 15mmol/L.

## 1.2. Product Characteristics

### ➤ Simple structure and reliable sealing

It adopts hermetic head faces with high degree pottery and corrosion resistance for opening and closing. It combines with Service, Settling Bed, Brine & Slow Rinse, Brine Refill and Fast Rinse.

### ➤ No water pass the valve in regeneration in single tank type.

### ➤ Manual function

Realize regeneration immediately by pushing manual button  at any time.



### ➤ Long outage indicator

If outage overrides 3 days, the time of day indicator “12: 12” will flash to remind people to reset the time of day. The other set parameters do not need to reset. The process will continue to work after power on.

### ➤ LED dynamic screen display LED

The stripe on dynamic screen flash, it indicates the control valve is in service, otherwise, it is in regeneration cycle.

### ➤ Buttons lock

No operations to buttons on the controller within 1 minute, button lock indicator light on which represent buttons are locked. Before operation press and hold the  and  buttons for 5 seconds to unlock. This function can avoid incorrect operation.

### ➤ Four kinds of meter type can be selected (Suite for F83A3)

Model	Name	Instruction
A-01	Meter Delayed	Regenerate on the day although the available volume of treated water drops to zero (0). Regeneration starts at the regeneration time.
A-02	Meter Immediate	Regenerate immediately when the available volume of treated water drops to zero(0).
A-03	Intelligent Meter Delayed	Meter Delayed Regeneration type, but by setting Resin Volume, Feed Water Hardness, Regeneration Coefficient, the controller will calculate the System Capacity.
A-04	Intelligent Meter Immediate	Meter Immediately Regeneration Type, but by setting Resin Volume, Feed Water Hardness, Regeneration Coefficient, the controller will calculate the System Capacity.

## MODEL:93504-F83A1/93604-F83A3

### ➤Interchange of time clock type and meter type

When the valve is set as time clock type (Such as F83A1), it can be transformed to meter type by dialing a blue switch (Refer to Figure 1) to transfer it to be meter type.

“ON” indicates meter type, “1” indicates time clock type. (Note: After dialing the switch, the valve shall restart.)

### ➤Interlock function

It has a function of interlock to realize only one valve in regeneration but the other valves are in service while several valves parallel in system. In multi-steps treatment systems such as RO pre-treatment, when several valves are in series, there is only one valve in regeneration or washing to ensure pass water all the times.(Application refer to Figure 3-5)

### ➤Signal output

There is a signal output connector on main control board. It is for controlling external wiring( Refer to Figure from Figure3-1 to Figure 3-4).

There are two types of output modes: b-01 Mode: Turn on start of regeneration and shut off end of regeneration; b-02 Mode: Signal available only at intervals of each status.

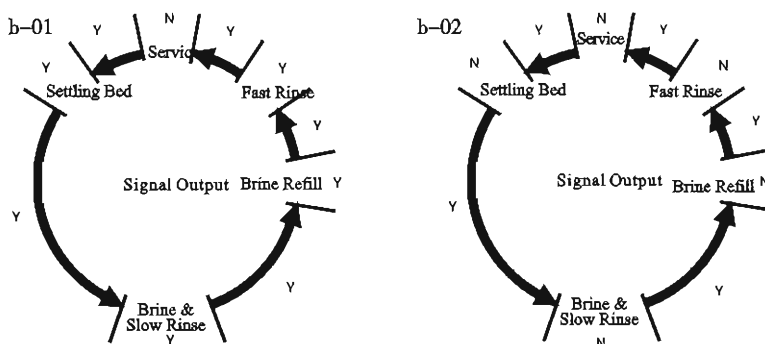

### ➤Remote handling input

This connector can receive external signal, used together with PLC, and computer etc. to control the valve. (Application refers to Figure3-6)

### ➤Pressure relief connector

There is no signal in settling bed status, but the signals exist in the other status. The pump doesn't work in settling bed status to protect the pump.

### ➤Maximum interval regeneration days (Suit for F83A3)

Under the situation of service reaching the setting days and the volume not yet, it could enter into regeneration process forcibly when current time is the same as regeneration time.

### ➤All parameters can be modified

According to the water quality and usage, the parameters in the process can be adjusted.

# MODEL:93504-F83A1/93604-F83A3

## 1.3. Service Condition

Runxin Valve should be used under the below conditions:

Items		Requirement
Working conditions	Water pressure	0.15MPa~0.6MPa
	Water temperature	5℃~50℃
Working environment	Environment temperature	5℃~50℃
	Relative humidity	≤95% (25℃)
	Electrical facility	AC100~240V/50~60Hz
Inlet water quality	Water turbidity	<2FTU
	Water hardness	<15mmol/L
	Free chlorine	<0.1mg/L
	Iron <sup>2+</sup>	<0.3mg/L
	(CODMn)	<2mg/L (O <sub>2</sub> )

● When the water turbidity exceeds the conditions, a filter should be installed on the inlet of control valve.

● When the water hardness exceeds the conditions, the outlet water hardness will hardly reach the requirement of boiler feed water (0.03 mmol/L) . It is suggested to adopt a second grade softener.

## 1.4. Product Structure and Technical Parameters

The appearance is just for reference. It is subject to the real product.

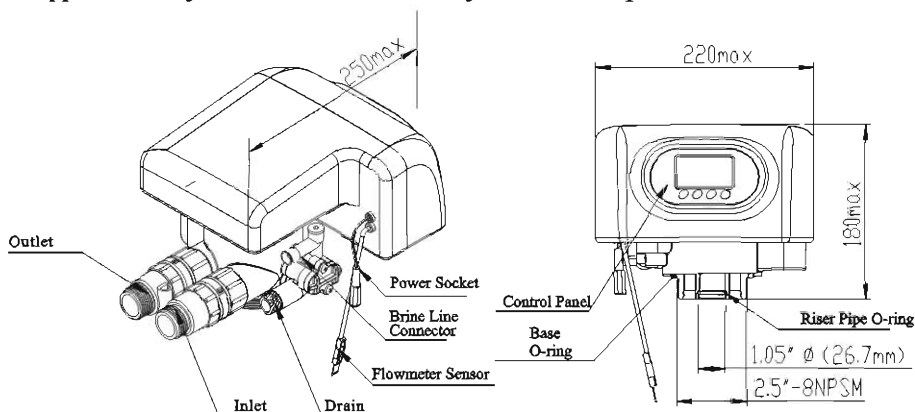

## 1.5. Installation

### A. Installation notice

Before installation, read all those instructions completely. Then obtain all materials and tools needed for installation.

The installation of product, pipes and circuits, should be accomplished by professional to ensure the normal operation of the product.

Perform installation according to the relative pipeline regulations and the specification of Water Inlet, Water Outlet, Drain Outlet, Brine Line Connector.

### B. Device location

- ①The filter or softener should be located close to the drain.
- ②Ensure the unit is installed in enough space for operating and maintenance.
- ③Brine tank need to be close to softener.
- ④The unit should be kept away from heat sources, and not be exposed outdoors. Sunshine or rain will cause the system damage.
- ⑤Please avoid to install the system in one Acid/Alkaline, Magnetic or strong vibration circumstance, because above factors will cause the system disorder.
- ⑥Do not install the filter or softener, drain pipeline in surroundings where is below 5°C, or above 50°C.
- ⑦One place is recommended to install the system which cause the minimum loss in case of water leakage.

### B. Pipeline installation

#### ①Install control valve

a. As the Figure 1-1 shows, select the riser pipe with 26.7mm OD, glue the riser pipe to the bottom strainer and put it into the mineral tank, cut off the exceeding tube out of tank top opening. Plug the riser tube in case of mineral entering.

b. Fill the mineral to the tank, and the height is in accordance with the design code.

c. Remove the tap covering on the central tube and check if the riser tube is on the center of tank.

d. Install the top distributor to the valve and insert the riser tube into control valve and screw tight control valve.

#### Note:

●The length of riser tube should be neither 2mm higher nor 5mm lower than tank top opening height, and its top end should be rounded to avoid damage of O-ring Inside the valve.

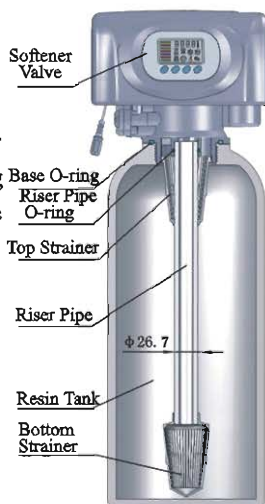

Figure 1-1



## MODEL:93504-F83A1/93604-F83A3

- Avoid floccule substance together with resin to fill in the mineral tank.
- Avoid O-ring inside control valve falling out while rotating it on the tank.

### ② Install animated connector

As Figure 1-2 shows, put the sealing ring into the nut of animated connector, and screw it in the water inlet.

### ③ Install flow meter

As Figure 1-2 shows, put the sealing ring into the nut of flow meter, screw it in the water outlet; insert the sensor into flow meter.

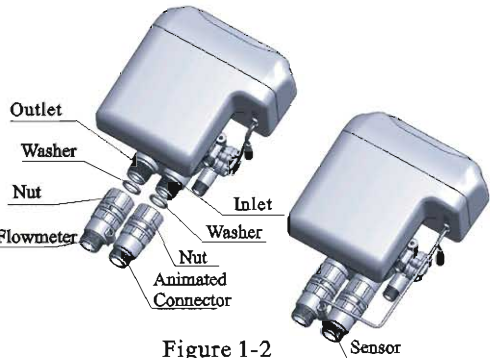

Figure 1-2

### ④ Pipeline connection

- As Figure 1-3 shows, install a pressure gauge in the water inlet.
- Install a ball valve in the inlet and outlet pipeline. (Or adopt F70A/F70C valve).
- Install a check valve in the water outlet.
- Inlet pipeline should be in parallel with outlet pipeline. Support inlet and outlet pipeline with fixed holder.

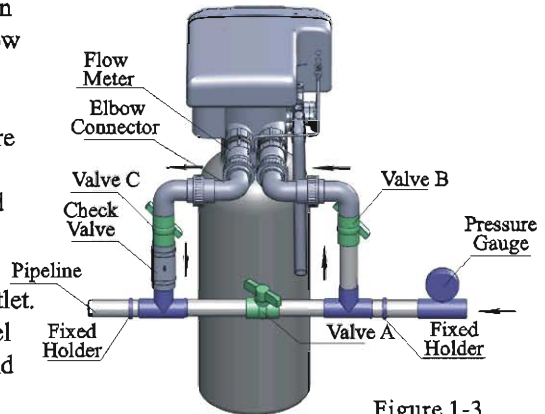

Figure 1-3

Note:

- If making a soldered copper installation, do all the soldering before connecting the pipes to the valve. Torch heat will damage plastic parts.
- When turning threaded pipe fittings onto plastic fitting, use care not to cross thread or broken valve.
- If the valve belongs to time clock type, there are no step ② and ③.

### ⑤ Install drain pipeline

- As the Figure 1-4 shows, insert drain line flow control into drain outlet.
- Screw drain hose connector into drain outlet, and lock it.
- Locate the drain hose well as the Figure 1-4 show.

Note:

- Control valve should be higher than the drain outlet, and be better not far from the drain hose.
- Be sure not to connect drain with sewer, and leave a certain space between them, in case wastewater are absorbed into the water treatment equipment, such as showed in the Figure 1-4.

## MODEL:93504-F83A1/93604-F83A3

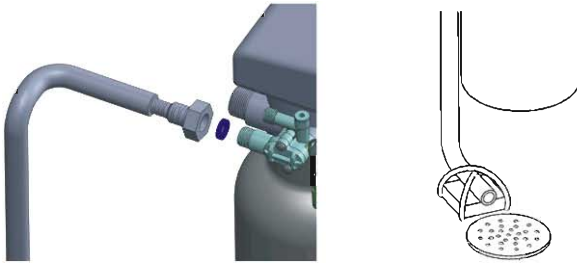

Figure 1-4

### ⑥ Connect brine tube

a . As Figure1-5 shows, slide 3/8" brine tube hose connector over end of brine tube.

b . Insert tube bushing into the end of brine tube.

c . Insert the red brine line flow control into valve brine line connector(Attention: cone side of control should face into valve)

d. Tighten brine draw hose connector onto brine line connector.

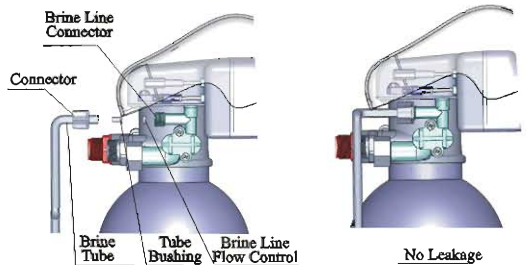

Figure 1-5

e . Connect the other end of brine tube with the brine tank. ( The liquid level controller and air-blocker should be installed in the brine tank.)

Remark: The brine tube and drain pipeline should not be bended or plugged.

## 2. Basic Setting & Usage



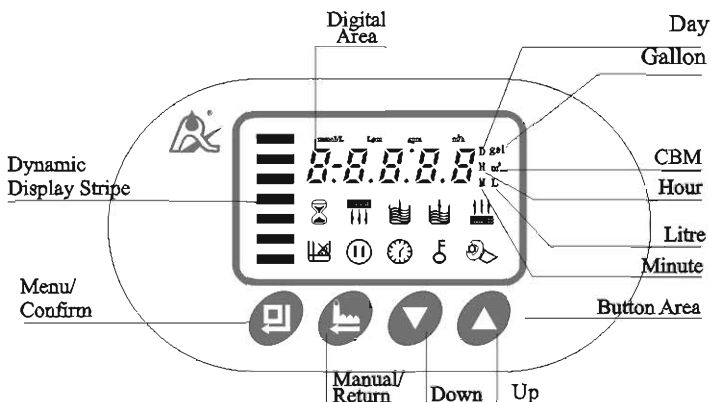

### 2.1. The Function of PC Board









**A.  Time of day indicator**

-  Light on, display the time of day.
- When “12:12” light flash, remind you to reset the time of day if electrical service interrupted for more than 3 days (If electrical service is interrupted within 3 days, it doesn't need to reset the time. )









**B.  Button lock indicator**

-  Light on, indicate the buttons are locked. At this moment, any single button will not work (No operation in one minute,  will light on and lock the buttons.)
- Solution: Press and hold both  and  for 5 seconds until the  light off.







**C.  Program mode indicator**

-  Light on, enter program display mode. Use  or  to view all values.
-  Flash and enter program set mode. Press  or  to adjust values.







**D.  Manu/Confirm button**

- Press ,  light on, enter program display mode and use  or  to view all values.
- In program display mode, press ,  flash, enter program set mode, press  or  and adjust values.
- Press  after all program are set, and then the voice “Di ” means all setting are success and return program display mode.

**E.  Manual/Return button**

- Press  in working conditions, it can proceed to next step. (Example: when the outlet water fails to reach the requirement, you can press  to end the service and start an immediate rising. During the process of rising, pressing the  button can end one step in advance and proceed to the next step.)
- Press  in program display mode, and it will return in Service. Press  in program set mode, and it will return program display mode.
- Press  while adjusting the value, then it will return program display mode directly without saving value.









**F. Down  and Up **

- In program display mode, press  or  to view all values.
- In program set mode, press  or  to adjust values.
- Press and hold both  and  for 5 seconds to lift the Button Lock status.

# MODEL:93504-F83A1/93604-F83A3

## 2.2. Basic Setting & Usage

### A. Parameter specification

Function	Indicator	Factory Default	Parameter Set Range	Instruction
Control Mode	A-01	A-01	00:00 ~ 23:59	Set the time of day when use; “: ” flash
			A-01	Regenerate on the day although the available volume of treated water drops to zero (0). Regeneration starts at the regeneration time.
			A-02	Regenerate immediately when the available volume of treated water drops to zero(0).
			A-03	Meter Delayed Regeneration type, but by setting Resin Volume, Feed Water Hardness, Regeneration Coefficient, the controller will calculate the System Capacity. Regeneration mode same as A-01.
			A-04	Meter Immediately Regeneration Type, but by setting Resin Volume, Feed Water Hardness, Regeneration Coefficient, the controller will calculate the System Capacity. Regeneration mode same as A-02.
Regeneration Time	 02:00	02:00	00:00 ~ 23:59	Regeneration time; “: ” light on
Water Treatment Capacity	 10m <sup>3</sup>	10m <sup>3</sup>	0 ~ 99.99 m <sup>3</sup>	Only under A-01/02 mode, has this item.
Settling Bed Time	 30min.	30min.	0 ~ 99:59	Hr.: Min.
Brine & Slow Rinse Time	 60min.	60min.	0 ~ 99	Brine & Slow rinse time(Minute)
Brine Refill Time	 5min.	5min.	0 ~ 99	Brine refill time(Minute)
Fast Rinse Time	 10min.	10min.	0 ~ 99	Fast rinse time(Minute)
Maximum Interval Regeneration Days	H-30	30	0 ~ 40	Regenerate on the day even through the available volume of treated water do not drop to zero (0).
Service Days	 1-03D.	1-03D.	0 ~ 99	Only for Time Clock Type, regeneration by days
Service Hours	 1-20H.	1-20H.	0 ~ 99	Only for Time Clock Type, regeneration by hours
Resin Volume	50L	50L.	20—500L	Only under A-03/04 mode, has this item to calculate water treatment capacity.

## MODEL:93504-F83A1/93604-F83A3

Feed Water Hardness	Yd1.2	1.2	0.1—30.0	Only under A-03/04 mode, has this item to calculate water treatment capacity.
Exchange Factor	AL.65	0.65	0.30—0.99	Only under A-03/04 mode, has this item to calculate water treatment capacity.
Output Control Mode	b-01	01	01 or 02	Mode 01: Signal turn on start of regeneration and shut off end of regeneration. (Connection refer to the Figure P3) Mode 02: Signal available only intervals of regeneration cycles and in service. (Connection refer to the Figure P3)

### B. Process Display

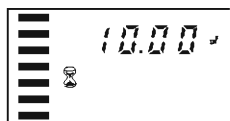

Figure A

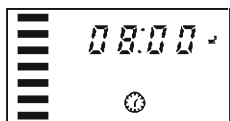

Figure B

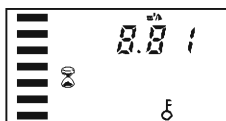

Figure C



Figure D

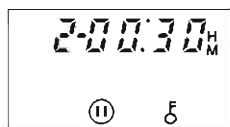

Figure E

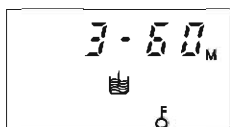

Figure F



Figure G

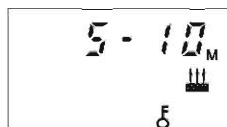

Figure H

### Illustration

● In Service status, the figure shows A/B/C/D; In Settling Bed status, it shows figure E/B; In Brine & Slow Rinse status, it shows F/B; In Brine Refill status, it shows figure G/B; In Fast Rinse status, it shows figure H/B. In each status, every figure shows for 15 seconds.

● Above displays are taking the Meter Type for example. For the Time Clock Type, it shows the rest days or hours, such as 1-03D or 1-20H.

● The display screen will only show “-00-” when the electrical motor is running.

● The time of day flashes continuously, such as “12: 12” flashes, indicates long outage of power. It reminds the client to reset the time of day.

● The display will show the error code, such as “-E1-” when the system is in error.

● Working process: Service → Settling Bed → Brine & Slow Rinse → Brine Refill → Fast Rinse → Service

















### C. Usage

After installation, parameter setting and trial running by the professional, the valve could be put into use. In order to ensure that the quality of outlet water can reach the requirement, the user should complete the below work:













①Ensure that there is solid salt all the time in the brine tank in the course of using when this valve is used for softening. The brine tank should be added by the clean water softening salts only, at least 99.5% pure, forbidding use the fine salt and iodized salt.

②Test the outlet water and raw water hardness at regular intervals. When the outlet water hardness is unqualified, please press  and the valve will start a temporary regeneration (It will not affect the original set operation cycle.)

③When the feed water hardness changes a lot, you can adjust the water treatment capacity as below:

Press and hold both  and  for 5 seconds to lift the lock status. Press , and the  light on, then press , the digital area show the control mode. If it shows A-01 or A-02, press ,  and value flash, press  and , change A-01/02 to A-03/04, press , then press  and , select water hardness item, it will show Yd1.2. Press , "1.2" flash, press  and  to adjust the water hardness value. When water hardness value is bigger, the water treatment capacity gets smaller. After adjustment, you will heard a sound of "Di", then finish adjustment. Press  to back to the working status.

For the estimation of water treatment capacity, you can refer to the professional application specification. When selecting A-03 or A-13 intelligent control mode, the controller will automatically calculate the water treatment capacity by setting resin volume, feed water hardness and regeneration factor.

④For A-01, A-01 or A-03 control mode (Meter delayed regeneration type), please pay attention whether the time is current or not. If the time is not right, you can adjust as follows: After lifting the lock status, press , the  and  light on. Then press , the  and hour value flash. Press  or  continuously, reset the hour value; Press  again,  and minute value flash. Press  or  continuously, reset the minute value; Press  and hear a sound "Di" then finish the adjustment. Press  exit and turn back the service status.

The regeneration parameters have been set when control valve left the factory. Generally, it does not need to reset. If you want enquiry and modify the setting, you can refer to the professional application specifications.

### 3. Applications

#### 3.1. Softener Flow Chart

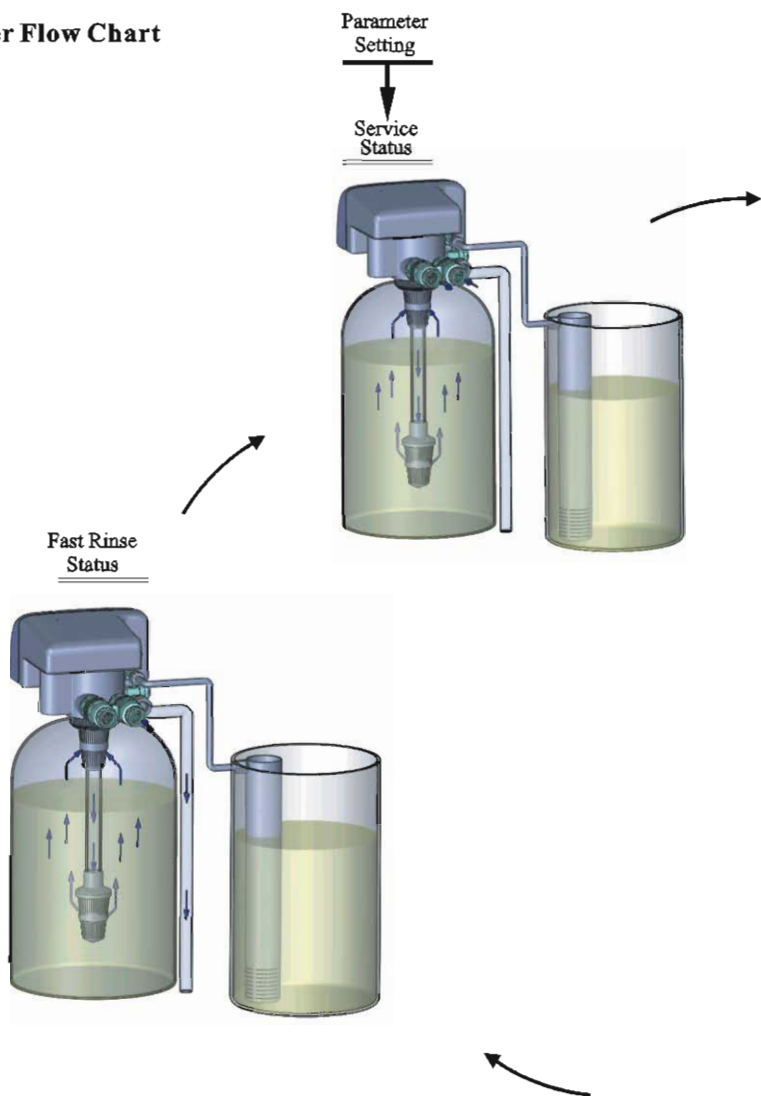

Settling Bed  
Status

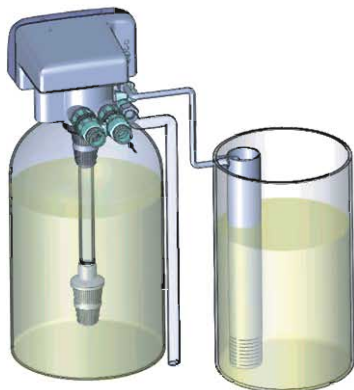

Brine & Slow  
Rinse Status

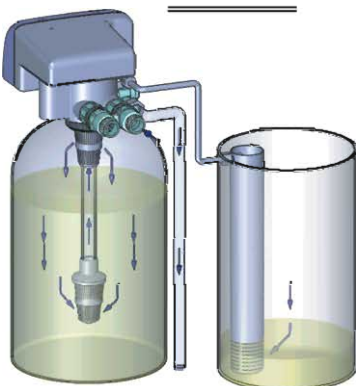

Brine Refill Status

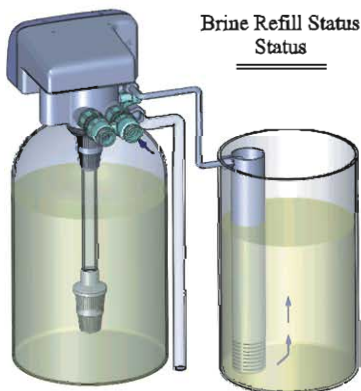



## MODEL:93504-F83A1/93604-F83A3

### 3.2. The Function and Connection of PC Board

Open the front cover of control valve, you will see the main control board and connection port as below:

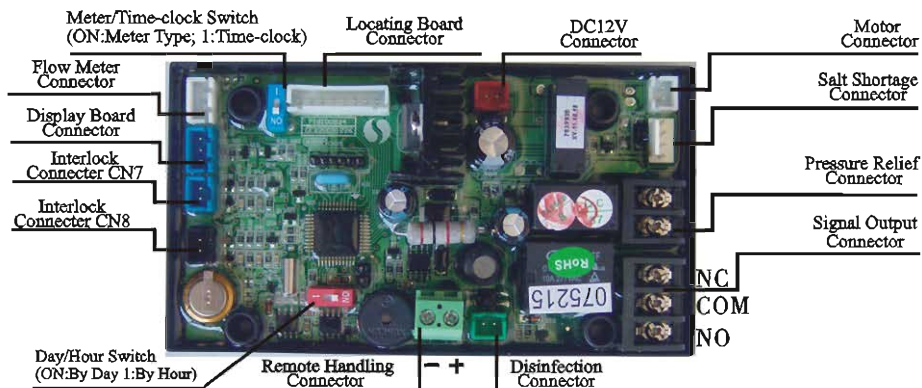

The main functions on main control board:

Function	Application	Explanation
Signal output connector b-01	Outlet solenoid valve	To strictly require no hard water to flow from outlet or controlling the liquid level in water tank.
Signal output connector b-02	Inlet solenoid valve or inlet pump	When inlet pressure is high, it needs to close the water inlet when valve is rotating to protect motor.
Pressure relief connector	Control the inlet by-pass to release pressure	When valve is rotating, pressure relief connector opened to prevent pressure increasing rapidly.
Interlock connector	To ensure not only one control valve regeneration or washing in system.	Use in RO Pre-treatment, water supply together but regeneration in turn. Second grade ion exchange equipment, etc.
Remote handling connector	Receipt signal to make the control rotate to next circle	It is used for on-line inspection system, PC connection, and realize automatic or remote controlling valve.

# MODEL:93504-F83A1/93604-F83A3

## A. Signal Output Connector

### 1) Control Solenoid Valve (Set b-01)

#### ① Solenoid Valve on Outlet Controls Water Level in Brine Tank.

Instruction: If system strictly require no hard water to flow from outlet in regeneration cycle (Mainly for no hard water flow out when valve is switching or valve in backwash or brine drawing positions), a solenoid valve could be installed on outlet, the wiring refer to Figure 3-1.

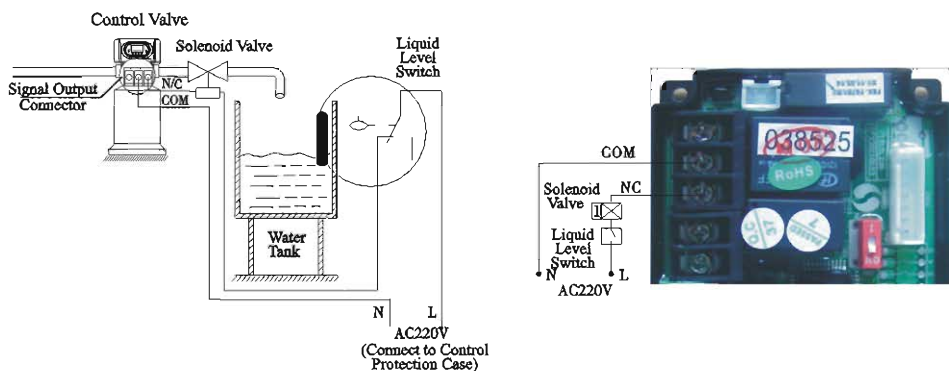

Figure3-1 Wring of Solenoid Valve on Outlet

#### Function:

When the valve in is service status, if the soft water tank is short of water, solenoid valve is open to supply soft water, but if the water tank has enough water, solenoid valve will be closed, so no soft water is supplied.

When the valve is in fast rinse status, there is no signal output. So, solenoid valve is closed, and now water flow into soft water tank.

#### ② Solenoid Valve on Inlet( Set b-02)

Instruction: When inlet pressure exceeds 0.6MPa, install a solenoid valve on inlet. Control mode is b-02. Pressure relieved when valve switching, the wiring refer to Figure 3-2. As Figure 3-3 shows, it also can use the pressure relief port to work.

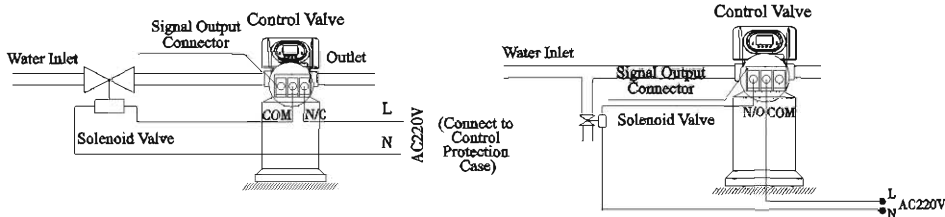

Figure 3-2 Wiring of Solenoid Valve on Inlet

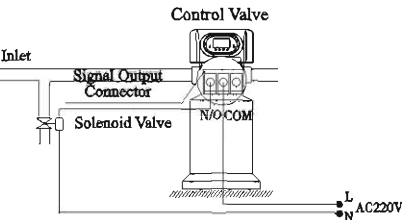

Figure3-3 Wiring of Pressure Relief Port

## MODEL:93504-F83A1/93604-F83A3

### Function:

When the inlet pressure is high, install a solenoid valve on inlet to ensure valve switching properly. When the valve is exactly in the position of Service, Settling Bed, Brine& Slow Rinse, Brine Refill and Fast Rinse, solenoid valve is open. When valve is switching, solenoid valve is closed, no water flow into valve to ensure valve switching properly. It could prevent the problem of mix water and water hammer.

Use interlock cable to realize valves in parallel and series in the same system which is suited for RO pretreatment system or second grade Na<sup>+</sup> system. The Wiring refer to Figure 3-4:

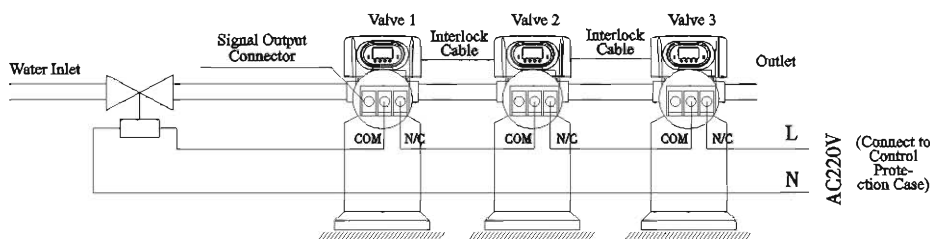

Figure 3-4 Wiring of Solenoid Valve in Inlet

### B. Interlock

#### Instruction:

In the parallel water treatment system, it ensures that only one valve is in regeneration or washing cycle and (n-1) valves in service, that is, realizing the function of supplying water simultaneously and regenerating individually, the wiring refer to Figure3-5.

In the series and parallel water treatment system(Second grade Na<sup>+</sup> Exchanger or RO pre-treatment system), it ensures only one valve in regeneration or washing cycle and there is/are water(s) in service.

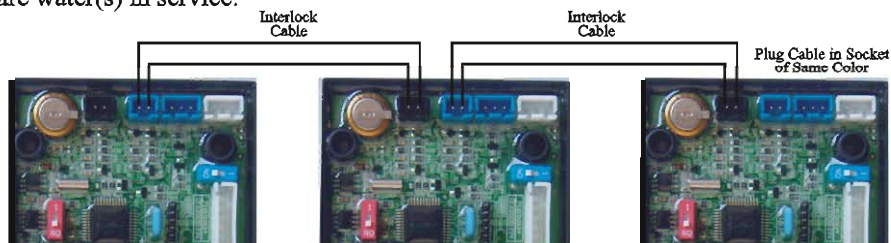

Figure 3-5 Network System Wiring with Interlock Cable

Note: Use Interlock Cable to connect CN8 to CN7 on the next valve in the loop.

One system with several valves, if interlock cable is disconnected, the system is divided into two individual systems.

# MODEL:93504-F83A1/93604-F83A3

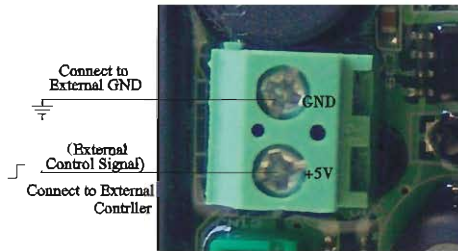

Figure 3-6 Wiring of Remote Input

## C. Remote Handling Connector

Online TDS meter monitors treated water other than a flow meter, or PLC controls the regeneration time. When the controller receives a contact closure from above instruments, regeneration begins. The wiring refers to Figure3-6:

## D. Interlock System

2 or more than 2 valves are interlocked connecting in one system and all valves are in service but regenerate individually. The wiring refer to Figure3-7:

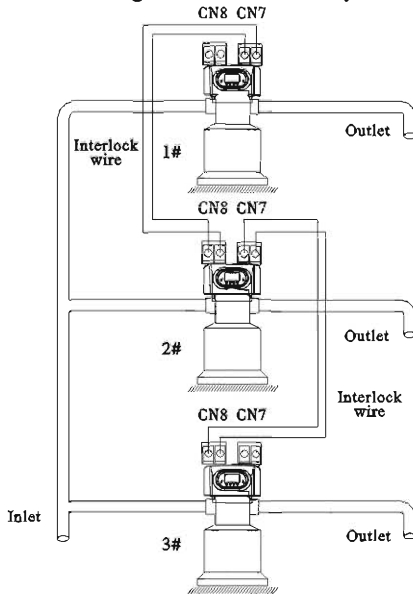

Figure 3-7 Interlock system

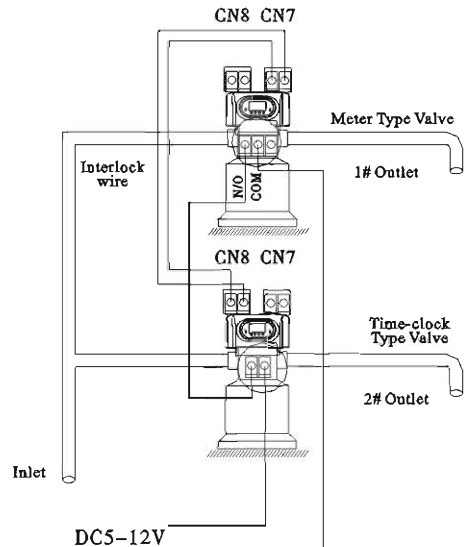

Figure 3-8 Series system

## E. Series System

This is a 2 or more than 2 valves system, all in service, with one flow meter for the entire system. For the time type valve, the regeneration time should be set and adjusted to the max; for the volume type valve, connect its signal output connector with the remote handle connector of the time-type valve. That can realize the function of supplying water simultaneously and regenerating orderly. The wiring refers to Figure 3-8:

## MODEL:93504-F83A1/93604-F83A3

### 3.3. System Configuration and Flow Rate Curve

#### A. Product Configuration

Product configuration with tank, resin volume, brine tank and injector

Tank Size (mm)	Resin Volume (L)	Flow Rate (t/h)	Brine Tank Size (mm)	The Minimum Salt Consumption for Regeneration (Kg)	Injector Model
φ 255 × 1390	50	2.2	φ 390 × 810	5.00	6305
φ 300 × 1650	75	3.2	φ 450 × 940	7.50	6306
φ 355 × 1650	125	4.3	φ 500 × 1060	12.50	6308

Attention: The flow rate calculation is based on working flow rate of 45m/hr; the minimum salt consumption for regeneration calculation is based on salt consumption 100g / (L resin).

#### B. Flow Rate characteristic

##### 1). Pressure-flow rate curve

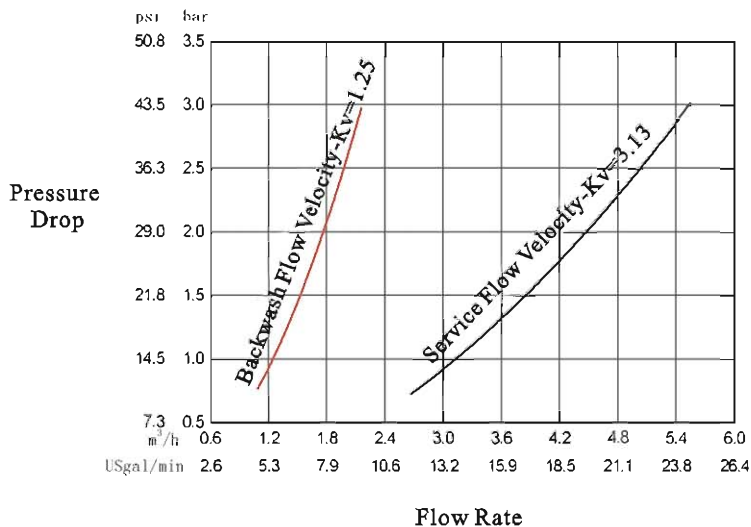

## MODEL:93504-F83A1/93604-F83A3

### 2). Injector parameter table

Inlet Pressure Mpa	Draw Rate (L/M)									
	6301 Coffee	6302 Pink	6303 Yellow	6304 Blue	6305 White	6306 Black	6307 Purple	6308 Red	6309 Green	6310 Orange
0.15	0.81	1.12	1.58	2.21	2.45	3.30	3.44	4.08	5.19	5.69
0.20	0.95	1.41	1.87	2.53	2.89	3.88	4.21	4.83	5.36	6.80
0.25	0.99	1.61	2.08	2.79	3.30	4.30	4.66	5.39	6.86	7.65
0.30	1.30	1.81	2.18	3.05	3.66	4.74	5.15	5.95	7.50	8.60
0.35	1.45	1.96	2.39	3.27	3.94	5.02	5.55	6.51	8.30	9.57
0.40	1.56	2.12	2.55	3.50	4.25	5.41	5.88	6.77	8.74	9.90

### 3). Configuration for Standard Injector and Drain Line Flow Control

Tank Dia. mm	Injector Model	Injector Color	Draw Rate	Slow Rinse	Brine Refill	DLFC	Backwash / Fast Rinse
			L/m	L/m	L/m		L/m
250	6305	White	3.66	2.81	4.3	3#	14.4
300	6306	Black	4.74	3.32	4.2	3#	14.4
350	6308	Red	5.95	4.0	4.0	4#	22.8

Remark: Above data for the product configuration and relevant characteristics are only for reference. In actual use, it is subject to the different requirements of raw water hardness and application.

### 3.4. Parameter settlement

#### ①Service TimeT1

Water Treatment Capacity:

$$Q = V_R \times K \div Y_D \quad (\text{m}^3)$$

- Hardness of inlet water ( mmol/L)
- Exchange coefficient (mmol/L) 400~1000.  
Down-flow regeneration, take 400~750.  
Up-flow regeneration, take 450~1000.  
If the inlet water hardness is higher, the coefficient is smaller.
- Resin volume ( m<sup>3</sup> )

## MODEL:93504-F83A1/93604-F83A3

By hours:  $T1=Q \div Q_h$  ( hour )

Water treatment capacity per hour (  $m^3/h$  )

Water treatment capacity (  $m^3$  )

By days:  $T1=Q \div Q_d$  ( day )

Water treatment capacity per day (  $m^3/d$  )

Water treatment capacity (  $m^3$  )

②Settling bed time T2: The time resin falls down to the bottom is suggested to be set between 20minutes~2hours.

③Brine & Slow rinse time T3

$$T3=(40\sim50) \times H_r \text{ ( min )}$$

$$\text{Generally, } T3=45H_r \text{ ( min )}$$

In this formula,  $H_r$ —The height of resin in exchange tank ( m )

④Brine refill timeT4

$$\text{Down-flow regeneration: } T4=0.45 \times V_r \div \text{Brine refill speed ( min )}$$

$$\text{Up-flow regeneration: } T4=0.34 \times V_r \div \text{Brine refill speed ( min )}$$

In this formula,  $V_r$ — Resin volume (  $m^3$  )

The Brine refill speed is related to the inlet water pressure. It is suggested to lengthen 1~2 minutes of calculated brine refilling time to make sure there is enough water in tank. ( The condition is that there is a level controller installed in the brine tank )

⑤Fast rinse time T5

$$T5=12 \times H_r \text{ ( min )}$$

Generally, the water for fast rinse is 3~6 times of resin volume. It is suggested to be set 10~16 minutes, but subject to the outlet water reaching the requirement.

⑥ Exchange coefficient

$$\text{Exchange coefficient} = E / (k \times 1000)$$

In this formula,  $E$ —Resin working exchange capability (  $mol/m^3$  ) , it is related to the quality of resin. Down-flow regeneration, take 800~900. Up-flow regeneration, take 900~1200.

$K$ —Security coefficient, always take 1.2~2. it is related to the hardness of inlet water: the higher the hardness is, the bigger the  $K$  is.

⑦Regeneration time: The whole cycle for generation is about two hours. Please try to set up the regeneration time when you don't need water according to the actual situation.

The calculation of parameters for each step is only for reference, the actual proper time will be determined after adjustment by water exchanger supplier. This calculation procedure of softener is only for industrial application; it is not suitable for small softener in residential application.

### 3.5. Parameter Enquiry and Setting

#### 3.5.1. Parameter Enquiry

When light on, press and hold both and for 5 seconds to lift the button lock status; then press and light on, enter to program display mode; press or to view each value according to below process. ( Press exit and turn back to service status )

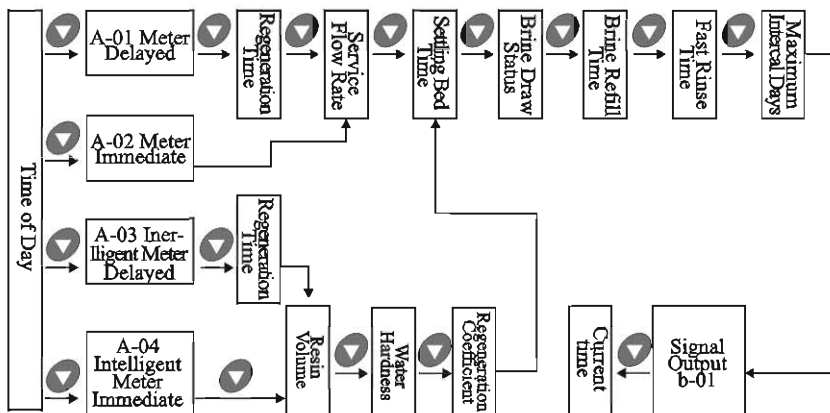

#### 3.5.2. Parameter Setting



















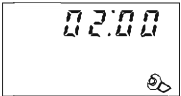





















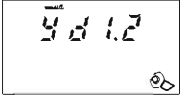





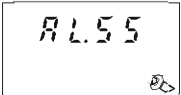

In program display mode, press and enter into the program set mode. Press or to adjust the value.

#### 3.5.3. The steps of parameter setting

















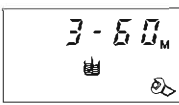







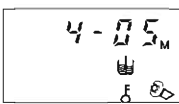





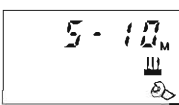



Item	Process Step	Symbol
Time of Day	<p>When time of day “12:12” continuously flash, it reminds to reset;</p> <p>1. Press  to enter into the program display mode; both  and  symbol light on, “:” flash;</p> <p>2. Press , both  and hour value flash, through  or  to adjust the hour value;</p> <p>3. Press  again, both  and minute value flash, through  or  to adjust the minute value;</p> <p>4. Press  and hear a sound “Di”, then finish adjustment, press  to turn back.</p>	
Control Mode	<p>1. In control mode display status, press  and enter into program set mode,  and 01 value flash;</p> <p>2. Press  or , set the value to be A-02, A-03 or A-04 control mode;</p> <p>3. Press  and hear a sound “Di”, then finish adjustment, press  to turn back.</p>	



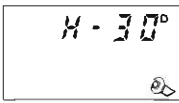





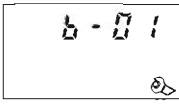



MODEL:93504-F83A1/93604-F83A3

<p>Regeneration Time</p>	<p>1. In regeneration time display status, press  and enter into program set mode.  and 02 flash;</p> <p>2. Press  or  to adjust the hour value;</p> <p>3. Press  again, and 00 flash, press  or  to adjust the minute value;</p> <p>4. Press  and hear a sound “Di”, then finish adjustment, press  to turn back.</p>	
<p>Water Treatment Capacity</p>	<p>1. In water treatment capacity display status, it shows  and 10.00. Press  and enter into the program set mode.  and 10.00 flash;</p> <p>2. Press  or  to adjust the water treatment capacity value (m<sup>3</sup>) ;</p> <p>3. Press  and hear a sound “Di”, then finish adjustment, press  to turn back.</p>	
<p>Resin Volume</p>	<p>1. In resin volume display status, it shows 100L. Press  and enters the into program set mode.  and 100 value flash;</p> <p>2. Press  or  to adjust the volume value(L);</p> <p>3. Press  and hear a sound “Di”, then finish adjustment, press  to turn back.</p>	
<p>Feed Water Hardness</p>	<p>1. In feed water hardness display status, it shows yd1.2. Press  and enter into the program set mode.  and 1.2 value flash;</p> <p>2. Press  or  to adjust the hardness value (mmol/L) ;</p> <p>3. Press  and hear a sound “Di”, then finish adjustment, press  to turn back.</p>	
<p>Exchange Factor</p>	<p>1. In exchange coefficient display status, it shows AL.55. Press  and enter into the program set mode.  and 55 flash;</p> <p>2. Press  or  to adjust the exchange factor value;</p> <p>3. Press  and hear a sound “Di”, then finish adjustment, press  to turn back.</p>	
<p>Settling Bed Time</p>	<p>1. In settling bed time display status, it shows  and 2-00:30. Press  and enter into the program set mode.  and 00 flash, press  or  to adjust the hour value;</p> <p>2. Press ,  and minute value 30 flash, press  or  to adjust the minute value;</p> <p>3. Press  and hear a sound “Di”, then finish adjustment, press to  turn back.</p>	

## MODEL:93504-F83A1/93604-F83A3

Brine & Slow Rinse Time	<p>1. In brine &amp; slow rinse time display status, it shows  and 3-60. Press  and enter into the program set mode.  and 60 flash;</p> <p>2. Press  or  to adjust the brine &amp; slow rinse time;</p> <p>3. Press  and hear a sound “Di”, then finish adjustment, press  to turn back.</p>	
Brine Refill Time	<p>1. In brine refill time display status, it shows  and 4-05:00, Press  and enter into the program set mode.  and 05:00 flash;</p> <p>2. Press  or  to modify the brine refill time;</p> <p>3. Press  and hear a sound “Di”, then finish adjustment, press  to turn back.</p>	
Maximum Interval Regeneration Days	<p>1. In maximum Interval regeneration days display status, it shows H-30. Press  and enter into the program set mode.  and 10 flash;</p> <p>2. Press  or  to adjust the Interval regeneration days;</p> <p>3. Press  and hear a sound “Di”, then finish adjustment, press  to turn back.</p>	
Fast Rinse Time	<p>1. In fast rinse time display status, it shows  and 5-10:00. Press  and enter into the program set mode.  and 10:00 flash;</p> <p>2. Press  or  to adjust the fast rinse time;</p> <p>3. Press  and hear a sound “Di”, then finish adjustment, press  to turn back.</p>	
Signal Output Mode	<p>1. In signal output mode display status, it shows b-01. Press  and enter into the program set mode.  And 01 flash;</p> <p>2. Press  or  to adjust the b-02;</p> <p>3. Press  and hear a sound “Di”, then finish adjustment, press  to turn back.</p>	

For example, the fast rinse time of a softener is 12 minutes. After regenerating, the chl-  
oridion in the outlet water is always higher than normal, indicating that there is not enough  
time for fast rinse. If you lengthen the time to 15 minutes, the modification steps as follows:

- ① Press  and  hold both and to lift the button lock statues (  light off ) ;
- ② Press  , and  light on ;
- ③ Press  or  continuously until  light on. Then the digital area shows: 5-12M;
- ④ Press  ,  and 12 flash ;
- ⑤ Press  continuously until 12 changed to 15 ;

⑥ Press  , there is a sound “Di” and the figure stop flashing; the program back to enquiry status;

⑦ If you want to adjust other parameters, you can repeat the steps from ② to ⑤; If you don't, press  and quit from the enquiry status, the display will show the current service status.

### 3.6. Trial running



After installing the multi-functional flow control valve on the resin tank with the connected pipes, as well as setting up the relevant parameters, please conduct the trial running as follows:



A. Close the inlet valve B & C, and open the by-pass valve A. After cleaning the foreign materials in the pipe, close the by-pass valve A. (As Figure 3 shows)



B. Fill the brine tank with the planned amount of water and adjust the air check valve. Then add solid salt to the tank and dissolve the salt as much as possible.



C. Switch on power. Press  and go in the Service position, slowly open the inlet valve B to 1/4 position, making the water flow into the resin tank; you can hear the sound of air-out from the drain pipeline. After all air is out of pipeline, then open inlet valve B completely and clean the foreign materials in the resin tank until the outlet water is clean. It will take 8 ~ 10 minutes to finish the whole process.

D. Press  , turning the position to Settling Bed, make resin fall down to bottom completely;

E. Press  , turning the position to Brine& Slow Rinse;  light on and enter in the process of Brine& Slow Rinse. The air check valve close when control valve finished sucking brine, then slow rinse start to work. It is about 60 ~ 65minutes for whole process.

F. Press  to Brine refill position.  light on and it indicates the brine tank is being refilled with water to the required level. It takes about 5 ~ 6minutes, then add solid salt to the brine tank.

G. Press  , turning to Fast Rinse position.  light on and start to fast rinse. After 10 ~ 15minutes, take out some outlet water for testing: if the water hardness reaches the requirement, and the chloridion in the water is almost the same compared with the inlet water, then go to the next step.

H. Press  , making the control valve return to Service Status;  light on and start to run.

Note:

● When the control valve enter into the regeneration status, all program can be finished automatically according to the setting time; if you want one of steps terminated early, you can press .

● If water inflow too fast, the media in tank will be damaged. When water inflow slowly, there is a sound of air emptying from drain pipeline.

● After changing resin, please empty air in the resin according to the above Step C.

● In the process of trial running, please check the water situation in all position, ensuring there are no resin leakage.

● The time for Backwash, Brine& Slow Rinse, Brine Refill and Fast Rinse position can be set and executed according to the calculation in the formula or suggestions from the control valve suppliers.

### 3.7. Trouble-Shooting

#### A. Control Valve Fault

Problem	Cause	Correction
1. Softener fails to regenerate.	A. Electrical service to unit has been interrupted. B. Regeneration cycles set incorrect. C. Controller is defective. D. Motor fails to work.	A. Assure permanent electrical service (Check fuse, plug, pull chain or switch). B. Reset regeneration cycles. C. Replace controller. D. Replace motor.
2. Regeneration time is not correct.	A. Time of Day not set correctly. B. Power failure more than 3 days.	Check program and reset time of day.
3. Softener supplies hard water.	A. Bypass valve is open or leaking. B. No salt in brine tank. C. Injector plugged. D. Insufficient water flowing into brine tank. E. Leak at O-ring on riser pipe. F. Internal valve leak. G. Regeneration cycles not correct. H. Shortage of resin. I. Bad quality of feed water or turbine blocked. J. Rapid service flow rate or frequent shut off.	A. Close or repair bypass valve. B. Add salt to brine tank and maintain salt level above water level. C. Change or clean injector. D. Check brine tank refill time. E. Make sure riser pipe is not cracked. Check o-ring and tube pilot. F. Change valve body. G. Set correct regeneration cycles in the program. H. Add resin to mineral tank and check whether resin leaks. I. Reduce the inlet turbidity, clean or replace turbine. J. Slow down service flow rate or reduce shut off frequency.
4. Softener fails to draw brine.	A. Line pressure is too low. B. Brine line is plugged. C. Brine line is leaking. D. Injector is plugged. E. Internal control leak. F. Drain line is plugged. G. Sizes of injector and DLFC not match with tank.	A. Increase line pressure. B. Clean brine line. C. Replace brine line. D. Clean or replace new parts. E. Replace valve body. F. Clean drain line flow control. G. Select correct injector size and DLFC according to the P20 requirements.
5. Unit uses too much salt.	A. Improper salt setting. B. Excessive water in brine tank.	A. Check salt usage and salt setting. B. See problem no.6.

MODEL:93504-F83A1/93604-F83A3

Control Valve Fault (Continue)

<p>6. Excessive water in brine tank.</p>	<p>A. Overlong refilling time. B. Foreign material in brine line. C. Foreign material in brine valve and plug drain line flow control. D. Not install safety brine valve but power failure whiling salting. E. Safety brine valve breakdown.</p>	<p>A. Reset correct refilling time. B. Clean brine line. C. Clean brine valve and brine line. D. Stop water supplying and restart pr install safety brine valve in salt tank. E. Repair or replace safety brine valve.</p>
<p>7. Pressure lost or iron in conditioned water.</p>	<p>A. Iron in the water supply pipe. B. Iron mass in the softener. C. Fouled resin bed. D. Too much iron in the raw water.</p>	<p>A. Clean the water supply pipe. B. Clean valve and add resin cleaning chemical, increase frequency of regeneration. C. Check backwash, brine draw and brine tank refill. Increase frequency of regeneration and backwash time. D. Iron removal equipment is required to install before softening.</p>
<p>8. Loss of mineral through drain line.</p>	<p>A. Air in water system. B. Bottom strainer broken. C. Improperly sized drain line control.</p>	<p>A. Assure that well system has proper air eliminator control. B. Replace new bottom strainer. C. Check for proper drain rate.</p>
<p>9. Control cycle continuously.</p>	<p>A. Locating signal wiring breakdown. B. Controller is faulty. C. Foreign material stuck the driving gear. D. Time of regeneration steps were set to zero.</p>	<p>A. Check and connect locating signal wiring. B. Replace controller. C. Take out foreign material. D. Check program setting and reset.</p>
<p>10. Drain flows continuously.</p>	<p>A. Internal valve leak. B. When electricity fails to supply, valve stops backwash or fast rinse position.</p>	<p>A. Check and repair valve body or replace it. B. Adjust valve to service position or turn off bypass valve and restart when electricity supply.</p>
<p>11. Interrupted or irregular brine.</p>	<p>A. Water pressure too low or not stable. B. Injector is plugged or faulty. C. Air in resin tank. D. Floccules in resin tank during backwash.</p>	<p>A. Increase water pressure. B. Clean or replace injector. C. Check and find the reason. D. Clean the floccules in resin tank.</p>
<p>12. Water flow out from drain or brine pipe after regeneration.</p>	<p>A. Foreign material in valve which makes valve can't be closed completely. B. Hard water mixed in valve body. C. Water pressure is too high which result in valve doesn't get the right position.</p>	<p>A. Clean foreign material in valve body. B. Change valve core or sealing ring. C. Reduce water pressure or use pressure release function.</p>

MODEL:93504-F83A1/93604-F83A3

**Control Valve Fault (Continue)**

<p>13. Salt water in soften water.</p>	<p>A. Foreign material in injector or injector fails to work. B. Brine valve cannot be shut-off. C. Time of fast rinse too short.</p>	<p>A. Clean and repair injector. B. Repair brine valve and clean it. C. Extend fast rinse time.</p>
<p>14. Unit capacity decreases.</p>	<p>A. Unit fails to regenerate or regenerate not properly. B. Fouled resin bed. C. Salt setting not proper. D. Softener setting not proper. E. Raw water quality deterioration. F. Turbin has already been stucked.</p>	<p>A. Regenerate according to right way. B. Increase backwash flow rate and time, clean or change resin. C. Readjust brine drawing time. D. According to the test of outlet water, recount and reset. E. Regenerate unit by manual temporary then reset regeneration cycle. F. Disassemble flow meter and clean it or replace a new turbine.</p>

**B、Controller Fault**

Problem	Cause	Correction
<p>1. All indictors display on front panel.</p>	<p>A. Wiring of front panel with controller fails to work. B. Control board is faulty. C. Transformer damaged. D. Electrical service not stable.</p>	<p>A. Check and replace the wiring. B. Replace control board. C. Check and replace transformer. D. Check and adjust electrical service.</p>
<p>2. No display on front panel.</p>	<p>A. Wiring of front panel with controller fails to work. B. Front panel damaged. C. Control board damaged. D. Electricity is interrupted.</p>	<p>A. Check and replace wiring. B. Replace front panel. C. Replace control board. D. Check electricity.</p>
<p>3. E1 Flash</p>	<p>A. Wiring of locating board with controller fails to work. B. Locating board damaged. C. Mechanical driven failure. D. Faulty control board. E. Wiring of motor with controller is fault. F. Motor damaged.</p>	<p>A. Replace wiring. B. Replace locating board. C. Check and repair mechanical part. D. Replace control board. E. Replace wiring. F. Replace motor.</p>
<p>4. E2 Flash</p>	<p>A. Hall component on locating board damaged. B. Wiring of locating board with controller fails to work. C. Control board is faulty.</p>	<p>A. Replace locating board. B. Replace wiring. C. Replace control board.</p>
<p>5. E3 or E4 Flash</p>	<p>A. Control board is faulty.</p>	<p>A. Replace control board.</p>

# MODEL:93504-F83A1/93604-F83A3

## 3.8. Assembly & Parts

### Flow Meter Connector & Animated Connector

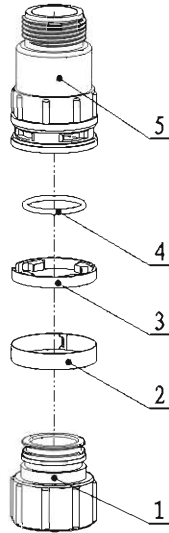
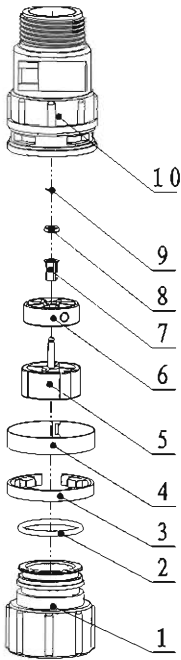

5447001 Flow Meter			
Item No.	Description	Part No.	Quantity
1	Animated nut	8945001	1
2	O-ring 28 × 2.65	8378081	1
3	Clip	8270001	1
4	Ferrule	8270002	1
5	Impeller supporter	5115001	1
6	Impeller	5436001	1
7	Rotate core	8211001	1
8	Bushing	8210001	1
9	Spring check ring	8945005	1
10	Shell	8002001	1

5457002 Animated Connector			
Item No.	Description	Part No.	Quantity
1	Animated nut	8945001	1
2	Ferrule	8270002	1
3	Clip	8270001	1
4	O-ring 28 × 2.65	8378081	1
5	Connector	8458038	1

# MODEL:93504-F83A1/93604-F83A3

## F83A3 (93604) Valve Body Assembly

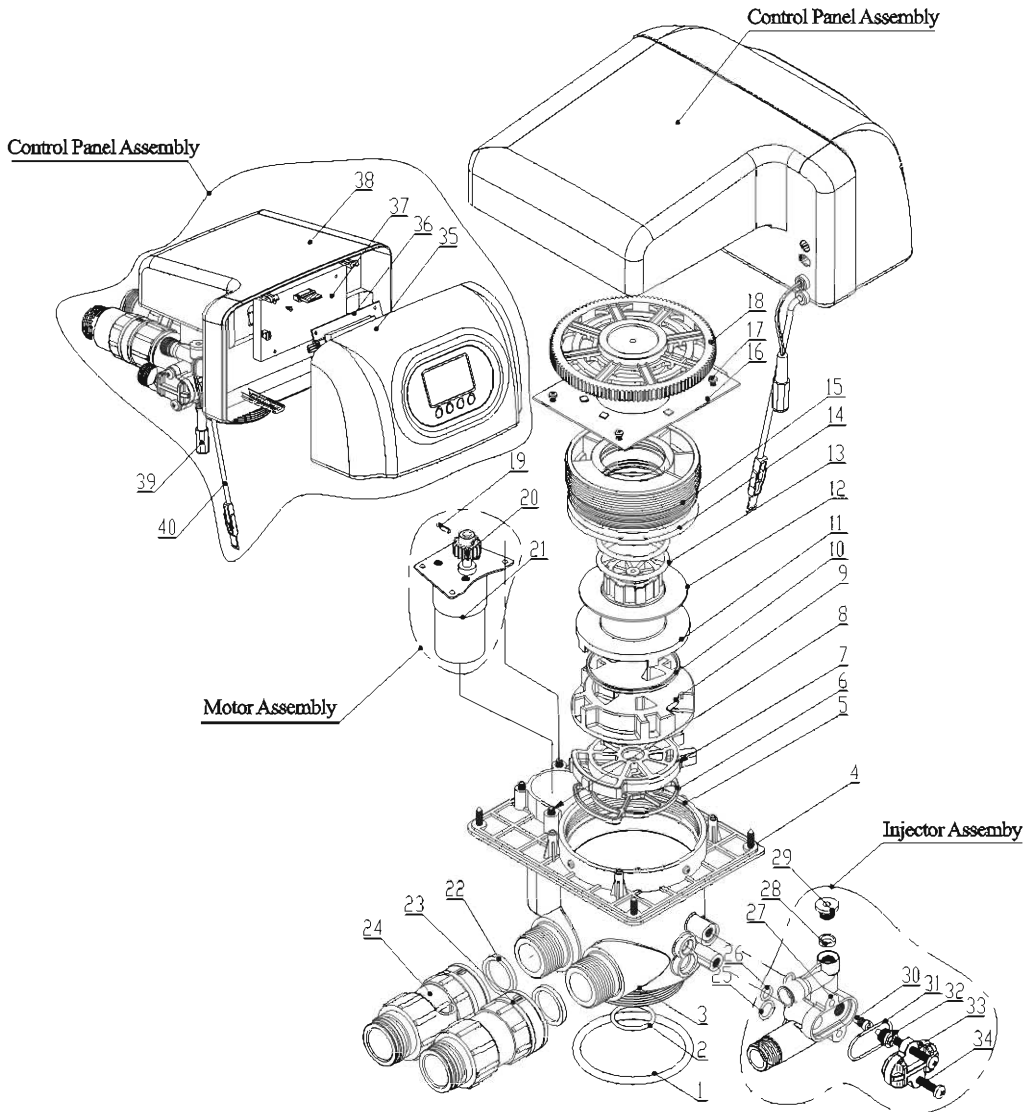



MODEL:93504-F83A1/93604-F83A3

F83 (93604) Valve Body Components

Item No.	Description	Part No.	Quantity	Item No.	Description	Part No.	Quantity
1	O-ring	8378143	1	21	Motor	6158011	1
2	O-ring	8378078	1	22	Washer	8371001	2
3	Valve Body	8022731	1	23	Joint	5457002	1
4	Screw, Cross	8909016	4	24	Flow Meter	5447007	1
5	Screw, Cross	8909008	4	25	O-ring	8378012	1
6	Seal Ring	8370051	1	26	O-ring	8378016	2
7	Fixed Disk	8469027	1	27	Injector Body	8008001	1
8	Screw, Cross	8902008	4	28	Seal Ring	8378025	1
9	Moving Disk	8459029	1	29	Plug	8323002	1
10	Moving Seal Ring	8370065	1	30	Throat, Injector	8467001	1
11	Shaft	8258014	1	31	O-ring	8378025	1
12	Anti-friction Washer	8216012	1	32	Nozzle, Injector	8454001	1
13	O-ring	8378123	2	33	Cover, Injector	8315001	1
14	O-ring	8378164	1	34	Screw, Cross	8902017	2
15	Fitting Nut	8092012	1	35	Front Cover	8300017	1
16	Locating Board	6380014	1	36	Display Board	6381003	1
17	Screw, Cross	8909008	1	37	Control Board	6382023	1
18	Terminal Gear	8241017	1	38	Dust Cover	8005016	1
19	Pin	8993003	1	39	Transformer Plug	5513001	1
20	Small Gear, Motor	8241015	1	40	Flow Meter Probe	6386001	1

## 4. Warranty Card

Dear client:

This warranty card is the guarantee proof of RUNXIN brand multi-functional flow control valve. It is kept by client self. You could get the after-sales services from the supplier which is appointed by RUNXIN manufacturer. Please keep it properly. It couldn't be retrieved if lost. It couldn't be repaired free of charge under the below conditions:

1. Guarantee period expired.(One year);
2. Damage resulting from using, maintenance, and keeping that are not in accordance with the instruction;
3. Damage resulting from repairing not by the appointed maintenance personnel;
4. Content in guarantee proof is unconfirmed with the label on the real good or be altered;
5. Damage resulting from force majeure.

Product Name	 润新 RUNXIN	Multi-functional Flow Control Valve for Water Treatment Systems		
Model		Code of Valve Body		
Purchase Company Name		Tel/Cel.		
Problem				
Solution				
Date of Repairing		Date of Accomplishment		Maintenance Man Signature

When product need warranty service, please fill in the below content and send this card together with the product to the appointed suppliers or Runxin company.

End-user Company Name		Tel/Cel.		
Purchase Company Name		Tel/Cel.		
Model		Code of Valve Body		
Tank Size $\phi$ ×		Resin Tank Size L	Raw Water Hardness	
Water Source: Ground-Water <input type="checkbox"/> Tap Water <input type="checkbox"/>		Water Treatment Capacity $m^3$	Setting Bed Time	
Brine & Slow Rinse Time min		Brine Refill Time min	Fast Rinse Time	
Problem Description				



---

**WENZHOU RUNXIN MANUFACTURING MACHINE CO.,LTD**

ADD: Jinger Road, Shatou Group, Linjiang, Lucheng District, Wenzhou, Zhejiang, China

Tel: +86-577-88635628 88630038 Fax: +86-0577-88633258

Http://www.run-xin.com Email:sales@run-xin.com